

Inventory Systems for Freezers and Refrigerators

2023

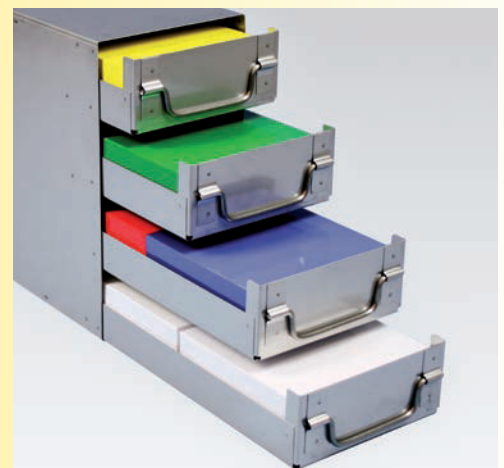
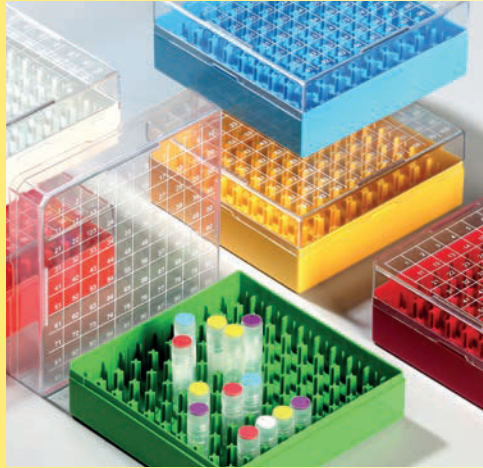

Online Information
www.Kryobox.de
www.EPPibox.com

NEW National Lab
EPPi Cryo Tubes
 with external thread



page 5

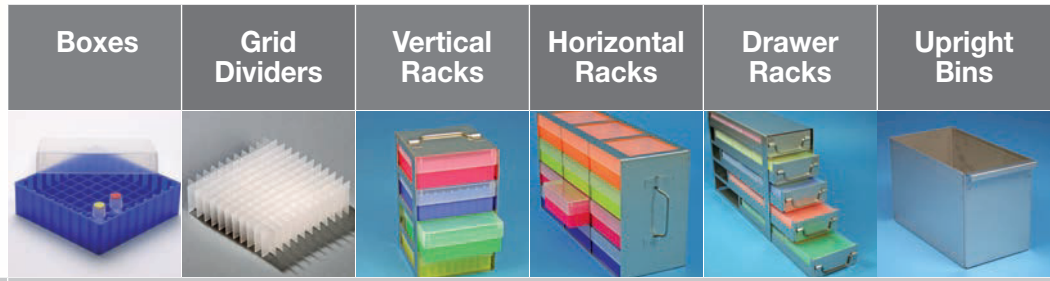

W x D (mm)		pages					
Polypropylene							
EPPi® Box Junior	67 x 67	9 + 77	9 + 77	*	*	*	47 + 53
EPPi® Box	130 x 130 133 x 133	6 – 36	37	39	40 – 41	42 – 46	47
EPPi® MAX Box	136 x 136	3	3	50	51 – 52	54 – 57	53
VICTOR Box with hinged lid	141 x 85 141 x 151	77		*	*	*	47 + 53
Polycarbonate							
EPPi® Cryobox	76 x 76	38 + 83		69	69	*	47 + 53
	130 x 130 133 x 133			39	40 – 41	42 – 46	47
Fiberboard							
ALPHA Box	136 x 136	48 – 49	49	50	51 – 52	54 – 57	53
ALPHA Box long2	136 x 268	58	58	*	*	*	53
BRAVO Box	133 x 133	60 – 61	61	62	63	42 – 46	47
BRAVO Box long2	133 x 257	64	64	*	*	*	47
CellBox	122 x 122 122 x 237 148 x 148 148 x 287	66	66	67	67	*	47 + 53
DELTA Box	133 x 133	65	61	62	63	42 – 46	47
FoxBox	136 x 136	59 + 77		50	51 – 52	54 – 57	53
MIKE Box	142 x 142	68	68	*	*	*	47 + 53
NANU Box	76 x 76	69	69	69	69	*	47 + 53
Stainless steel							
CNS Box	133 x 133	81	37 + 81	39	40 – 41	42 – 46	47
Slide Boxes							
Obi Box	96 x 122 100 x 230 185 x 230	76		*	*	*	47 + 53
Microtiter Plates and DeepWells							
All brands	86 x 128			70	71 – 72	73 – 75	47 + 53

* = on request

Autoclavable at +121°C · Polypropylene: -100°C up to +121°C · Polycarbonate: -196°C up to +121°C



NEW



EPPi® MAX

The ALPHA Box made of PP*



New: 136 x 136 mm

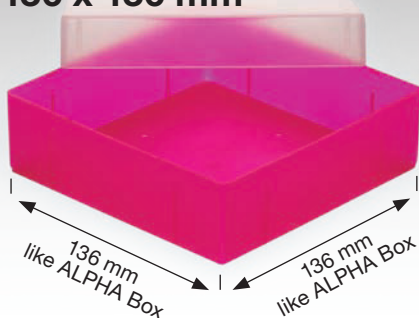

The Classic Box: 133 x 133 mm

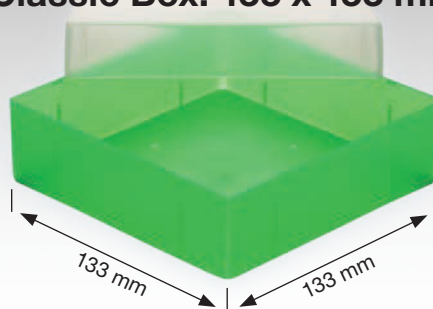

Box without Grid Divider

EPPi® MAX 50 height 52 mm **EPPi® MAX 45** height 45–53 mm

Colour	Cat. No.	Cat. No.
natural	KEAMAX50-C1NA	KEAMAX45-V1NA
neon-yellow	KEAMAX50-C1NY	KEAMAX45-V1NY
neon-blue	KEAMAX50-C1NB	KEAMAX45-V1NB
neon-green	KEAMAX50-C1NG	KEAMAX45-V1NG
neon-red/pink	KEAMAX50-C1NP	KEAMAX45-V1NP
neon-orange	KEAMAX50-C1NO	KEAMAX45-V1NO
black/black**	KEAMAX50-C1BB	KEAMAX45-V1BB



Box without Grid Divider

EPPi® 50 height 52 mm **EPPi® 45** height 45–53 mm

Colour	Cat. No.	Cat. No.
natural	KEA50-C1NA	KEA45-V1NA
neon-yellow	KEA50-C1NY	KEA45-V1NY
neon-blue	KEA50-C1NB	KEA45-V1NB
neon-green	KEA50-C1NG	KEA45-V1NG
neon-red/pink	KEA50-C1NP	KEA45-V1NP
neon-orange	KEA50-C1NO	KEA45-V1NO
black/black**	KEA50-C1BB	KEA45-V1BB

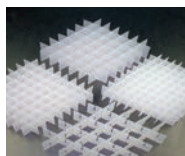

Matching Grid Dividers H = 30 mm

EPPi® MAX and all Boxes
136 x 136 mm

Cells	for Tubes (diameter)	Cat. No.
3x3	up to ca. 42.9 mm Ø	REM10300303K
4x4	up to ca. 32.0 mm Ø	REM10300404K
5x5	up to ca. 25.5 mm Ø	REM10300505K
6x6	up to ca. 21.0 mm Ø	REM10300606K
7x7	up to ca. 18.0 mm Ø	REM10300707K
8x8	up to ca. 15.7 mm Ø	REM10300808K
9x9	up to ca. 13.9 mm Ø	REM10300909K
10x10	up to ca. 12.5 mm Ø	REM10301010K
12x12	up to ca. 10.3 mm Ø	REM10301212K
14x14	up to ca. 8.7 mm Ø	REM10301414K
16x16	up to ca. 7.6 mm Ø	REM10301616K

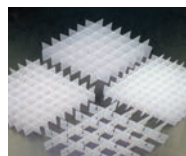

Matching Grid Dividers H = 30 mm

EPPi® Box and all Boxes
133 x 133 mm

Cells	for Tubes (diameter)	Cat. No.
3x3	up to ca. 41.2 mm Ø	RE10300303K
4x4	up to ca. 30.8 mm Ø	RE10300404K
5x5	up to ca. 24.5 mm Ø	RE10300505K
6x6	up to ca. 20.3 mm Ø	RE10300606K
7x7	up to ca. 17.3 mm Ø	RE10300707K
8x8	up to ca. 15.0 mm Ø	RE10300808K
9x9	up to ca. 13.0 mm Ø	RE10300909K
10x10	up to ca. 12.0 mm Ø	RE10301010K
12x12	up to ca. 9.8 mm Ø	RE10301212K

* PP=Polypropylene
** black/black: Lower half and lid black for light-sensitive samples

NEW



Why do only 81 cryo tubes fit into your cryoboxes?



The answer is quite simple: it's because you're not yet using our super-slim EPPi® cryo tubes, which at last enable you to store 100 tubes in our standard boxes. You probably won't find anyone able to explain why the unpopular 9x9 boxes were invented and have more or less established themselves as the standard throughout the world. Now, in any case, this expensive waste of space is over.

Your specimen material is valuable, rare or even unique. You are aware of the contamination risk when working with cryo tubes. If you have previously opted for contamination-prone tubes with an inner thread and silicon O-ring, there is no further need to keep making this "compromise", which has hopefully been free of consequences. Now 100 EPPi® cryo tubes with external thread fit into the standard box of 133x133 mm. Check out the benefits for yourself.

EPPi® Cryo Tubes



- ▶ GMP-oriented production under cleanroom conditions.
- ▶ Extensive and very detailed quality control measures during the production process.
- ▶ Batch inspection system with leak test to validate the process.
- ▶ Exclusive use of FDA-approved polypropylene for in vitro diagnostics. Both tube and screw top are made of the same medical grade material to achieve a 100% seal.
- ▶ The outer thread with QuickLock screw closure and the screw top with safe-sealing lip enable the tubes to be closed very quickly and opened with only half a rotation.
- ▶ Packaged in resealable upright pouches with batch label.
- ▶ EPPi® cryo tubes can be printed individually to meet customer requirements. Personalized barcodes and QR codes are also possible.

- Manufactured in accordance with ISO 13485, ISO 9001, ISO 14001
- Produced to GMP guidelines in a cleanroom
- Produced from FDA-approved polypropylene with an usable range from -196 °C to +121 °C
- Not cytotoxic according to ISO 10993-5
- Free of heavy metals and plasticizers
- RNase-/DNase-free, DNA-free
- ATP-free
- BSE-/TSE-free
- Pyrogen-free
- Sterilized to ISO 11137-2:2013
- VDMax25 Validation
- Sterility Assurance Level of 10⁻⁶
- Centrifugable up to 17,000 g



EPPi® Cryo Tubes, sterile

Cat. No.	Content	Height	Packing Unit
EPPi0SX*	0.5 ml	28.5 mm	1,000 (2x500)
EPPi1SPX	1.0 ml	36.1 mm	1,000 (2x500)
EPPi2SPX	2.0 ml	47.6 mm	1,000 (10x100)
EPPi4SP5	4.0 ml	73.2 mm	500 (5x100)
EPPi5SP5	5.0 ml	88.5 mm	500 (5x100)

* without printing, with separately packaged screw tops

EPPi® Cryo Tubes, non-sterile

Cat. No.	Content	Height	Packing Unit
EPPi0N*	0.5 ml	28.5 mm	1,000 (1x1,000)
EPPi1N*	1.0 ml	36.1 mm	1,000 (1x1,000)
EPPi2N*	2.0 ml	47.6 mm	1,000 (2x500)
EPPi4N*	4.0 ml	73.2 mm	1,000 (4x250)
EPPi5N*	5.0 ml	88.5 mm	1,000 (4x250)



EPPi® Colour Coding, 1 colour

Cat. No.	Colour	Packing Unit
EPPi8BU5	blue	500 (5x100)
EPPi8GR5	green	500 (5x100)
EPPi8RE5	red	500 (5x100)
EPPi8WH5	white	500 (5x100)
EPPi8YE5	yellow	500 (5x100)

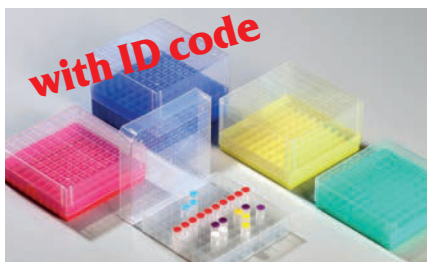

EPPi® Cryobox 133 x 133 mm, Polypropylene

Cat. No.	Article Name	Cells	for Vials	Height	Colours**
EPPi05□□**	Cryobox 0.5	10x10	0.5 ml	34 mm	NA □ BU □ YE □ GR □ RE □
EPPi10□□**	Cryobox 1.0	10x10	0.5 / 1.0 ml	40 mm	NA □ BU □ YE □ GR □ RE □
EPPi20□□**	Cryobox 2.0	10x10	1.0 / 2.0 ml	53 mm	NA □ BU □ YE □ GR □ RE □
EPPi40□□**	Cryobox 4.0	10x10	4.0 ml	79 mm	NA □ BU □ YE □ GR □ RE □
EPPi50□□**	Cryobox 5.0	10x10	4.0 / 5.0 ml	94 mm	NA □ BU □ YE □ GR □ RE □

** Add colour code to end of Cat. No.: NA = natural · BU = blue · YE = yellow · GR = green · RE = red

See page 6

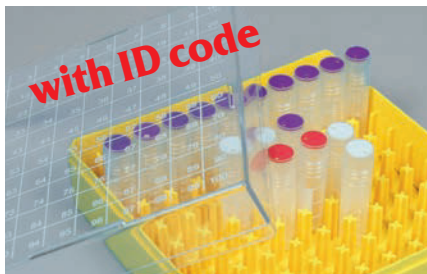

EPPi® Cryobox 133 x 133 mm, Polycarbonate

Cat. No.	Article Name	Cells	for Vials (ml)	Height (mm)	Colours**
KPC50-C100□□**	Cryobox 100	10x10	0.5 / 1.0 / 2.0	52	BU □ YE □ GR □ RE □ OR □ WH □
KPC50-C81□□**	Cryobox 81	9x9	2.0	52	BU □ YE □ GR □ RE □ OR □ WH □
KPC50-C25□□**	Cryobox 25	5x5	2.0	52	BU □ YE □ GR □ RE □ OR □ WH □
KPC95-C81□□**	Cryobox 81H	9x9	5.0	95	BU □ YE □ GR □ RE □

** Add colour code to end of Cat. No.: BU = blue · YE = yellow · GR = green · RE = red · OR = orange · WH = white

See page 38



EPPi® Cryo Tube Rack, Polycarbonate

Non-slip cryo tube rack with locking system for the star-base foot prevents the tubes from rotating when tightening and unscrewing the caps. Single-handed operation to make work fast and comfortable. Alphanumeric coding. Temperature-resistant from -196 °C up to +121 °C. Autoclavable.

Cat. No.	Holes	Ext. Dimensions WxDxH (mm)	Colours**
LCRWS50□□**	5x10	195x100x25	BU □ GR □ RE □ WH □

** Add colour code to end of Cat. No.: BU = blue · GR = green · RE = red · WH = white

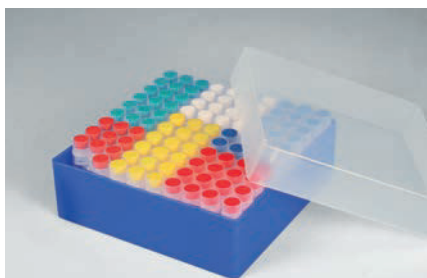

EPPi® MAX Cryobox 136 x 136 mm, Polypropylene

Cat. No.	Article Name	Cells	for Vials (ml)	Height (mm)	Colours**
KEAMAX45-V1□□**	EPPi® MAX Box 45	-	1.0 / 2.0	45-53	NA □ NB □ NY □ NG □ NP □ NO □ BB***
KEAMAX50-C1□□**	EPPi® MAX Box 50	-	1.0 / 2.0	52	NA □ NB □ NY □ NG □ NP □ NO □ BB***
REM10301010K	EPPi® MAX Divider	10x10	1.0 / 2.0	30	

** Add colour code to end of Cat. No.:

NA = natural · NB = neon-blue · NY = neon-yellow · NG = neon-green · NP = neon-red/pink · NO = neon-orange · BB*** = black/black

*** black/black: Lower half and lid black for light-sensitive samples

See page 3

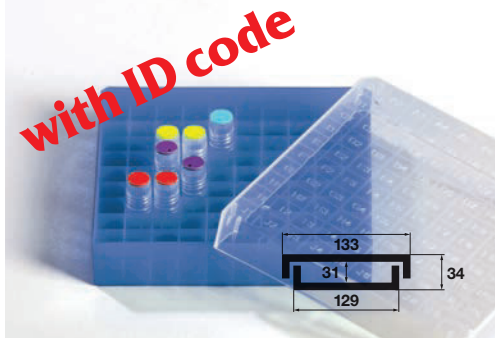

EPPi® Cryobox 0.5 / 10x10

For EPPi® cryo tubes with external thread or ordinary cryo tubes with internal thread. Transparent lid. With alphanumeric ID code on the lid. Anti-twist safety device.

Cat. No.	Colour	Cells	for Tubes	Height
EPPi05NA	natural	10x10	0.5 ml	34 mm
EPPi05BU	blue	10x10	0.5 ml	34 mm
EPPi05YE	yellow	10x10	0.5 ml	34 mm
EPPi05GR	green	10x10	0.5 ml	34 mm
EPPi05RE	red	10x10	0.5 ml	34 mm

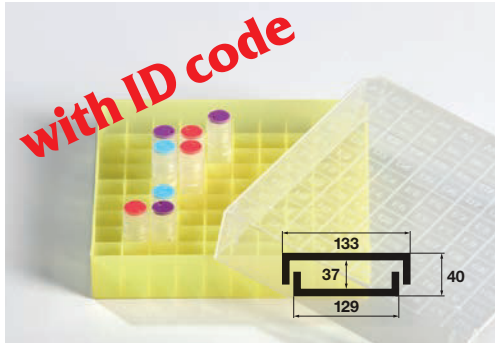

EPPi® Cryobox 1.0 / 10x10

For EPPi® cryo tubes with external thread or ordinary cryo tubes with internal thread. Transparent lid. With alphanumeric ID code on the lid. Anti-twist safety device.

Cat. No.	Colour	Cells	for Tubes	Height
EPPi10NA	natural	10x10	0.5 / 1.0 ml	40 mm
EPPi10BU	blue	10x10	0.5 / 1.0 ml	40 mm
EPPi10YE	yellow	10x10	0.5 / 1.0 ml	40 mm
EPPi10GR	green	10x10	0.5 / 1.0 ml	40 mm
EPPi10RE	red	10x10	0.5 / 1.0 ml	40 mm

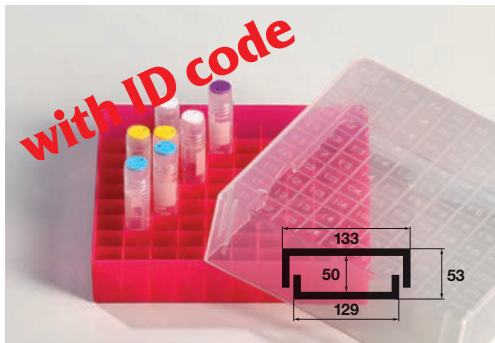

EPPi® Cryobox 2.0 / 10x10

For EPPi® cryo tubes with external thread or ordinary cryo tubes with internal thread. Transparent lid. With alphanumeric ID code on the lid. Anti-twist safety device.

Cat. No.	Colour	Cells	for Tubes	Height
EPPi20NA	natural	10x10	1.0 / 2.0 ml	53 mm
EPPi20BU	blue	10x10	1.0 / 2.0 ml	53 mm
EPPi20YE	yellow	10x10	1.0 / 2.0 ml	53 mm
EPPi20GR	green	10x10	1.0 / 2.0 ml	53 mm
EPPi20RE	red	10x10	1.0 / 2.0 ml	53 mm

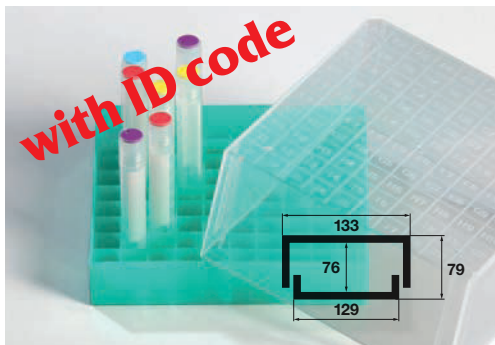

EPPi® Cryobox 4.0 / 10x10

For EPPi® cryo tubes with external thread or ordinary cryo tubes with internal thread. Transparent lid. With alphanumeric ID code on the lid. Anti-twist safety device.

Cat. No.	Colour	Cells	for Tubes	Height
EPPi40NA	natural	10x10	4.0 ml	79 mm
EPPi40BU	blue	10x10	4.0 ml	79 mm
EPPi40YE	yellow	10x10	4.0 ml	79 mm
EPPi40GR	green	10x10	4.0 ml	79 mm
EPPi40RE	red	10x10	4.0 ml	79 mm

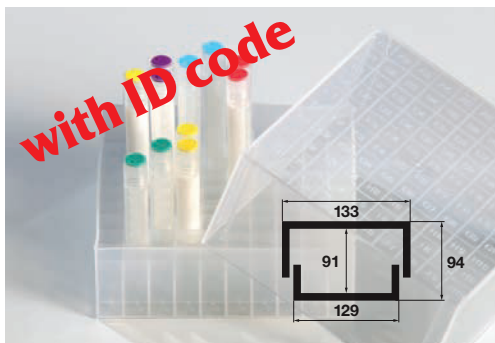

EPPi® Cryobox 5.0 / 10x10

For EPPi® cryo tubes with external thread or ordinary cryo tubes with internal thread. Transparent lid. With alphanumeric ID code on the lid. Anti-twist safety device.

Cat. No.	Colour	Cells	for Tubes	Height
EPPi50NA	natural	10x10	4.0 / 5.0 ml	94 mm
EPPi50BU	blue	10x10	4.0 / 5.0 ml	94 mm
EPPi50YE	yellow	10x10	4.0 / 5.0 ml	94 mm
EPPi50GR	green	10x10	4.0 / 5.0 ml	94 mm
EPPi50RE	red	10x10	4.0 / 5.0 ml	94 mm

Matching Racks

Vertical Racks
Please request!

Horizontal Racks
Please request!

Drawer Racks
Please request!

Upright Bins
page 47

Matching Racks

Vertical Racks
Please request!

Horizontal Racks
Please request!

Drawer Racks
Please request!

Upright Bins
page 47

Matching Racks

Vertical Racks
page 39

Horizontal Racks
page 40–41

Drawer Racks
page 42–43

Upright Bins
page 47

Matching Racks

Vertical Racks
page 39

Horizontal Racks
page 40–41

Drawer Racks
page 45

Upright Bins
page 47

Matching Racks

Vertical Racks
page 39

Horizontal Racks
page 40–41

Drawer Racks
page 45

Upright Bins
page 47

NEW

EPPI® 92

EPPI® 67

3 x 3 holes for **25 ml**
Eppendorf Conical Tubes*

5 x 5 holes for **5 ml**
Eppendorf Conical Tubes*

Hole diameter 30 mm as in
EPPI® Boxes for 50 ml
centrifuge tubes. External
dimensions 133 x 133 x 92 mm.

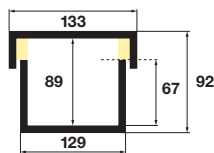

Hole diameter 17 mm as in
EPPI® Boxes for 15 ml
centrifuge tubes. External
dimensions 133 x 133 x 67 mm.

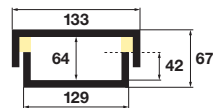

Cat. No.	Colour
KES92-CO9NA	natural
KES92-CO9NY	neon-yellow
KES92-CO9NB	neon-blue
KES92-CO9NG	neon-green
KES92-CO9NP	neon-red/pink
KES92-CO9NO	neon-orange
KES92-CO9BB	black/black**

**black/black: Lower half and lid black for light-sensitive samples
Other colours on request.

Cat. No.	Colour
KES67-CO25NA	natural
KES67-CO25NY	neon-yellow
KES67-CO25NB	neon-blue
KES67-CO25NG	neon-green
KES67-CO25NP	neon-red/pink
KES67-CO25NO	neon-orange
KES67-CO25BB	black/black**

**black/black: Lower half and lid black for light-sensitive samples
Other colours on request.

Made of polypropylene (PP) with two hole inserts.
With numeric ID code. Alphanumeric ID code on request.

* Eppendorf® and Eppendorf Tubes® are registered trademarks of Eppendorf AG Germany.





EPPi® 45 / 9x9 • height 45-53 mm variable

9x9 divider holds for 81 tubes up to 12.5 mm Ø. With alphanumeric ID code on all 4 sides. (See also page 12: KEB45.. with ID code in contrasting colour).

Cat. No.	Colour	Cat. No.	Colour
KEL45-V81NA	natural	KEL45-V81YE	yellow
KEL45-V81NY	neon-yellow	KEL45-V81BU	blue
KEL45-V81NB	neon-blue	KEL45-V81GR	green
KEL45-V81NG	neon-green	KEL45-V81RE	red
KEL45-V81NP	neon-red/pink	KEL45-V81VT	violet
KEL45-V81NO	neon-orange	KEL45-V81BL	black
KEL45-V81WH	white	KEL45-V81BB	black/black*

*black/black: Lower half and lid black for light-sensitive samples

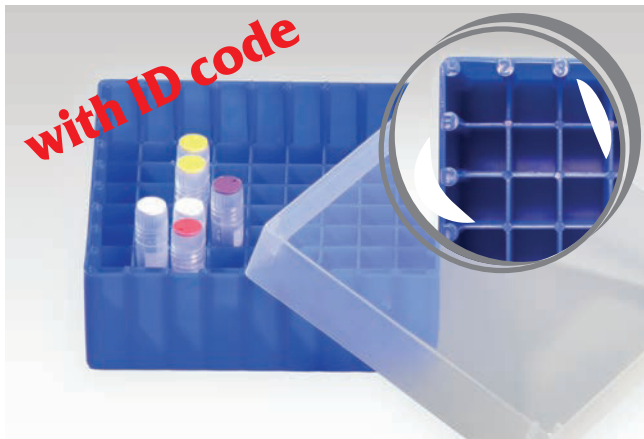

EPPi® 50 / 9x9 • height 53 mm fix

9x9 divider holds for 81 tubes up to 12.5 mm Ø. With alphanumeric ID code on all 4 sides. (See also page 14: KEB50.. with ID code in contrasting colour).

Cat. No.	Colour	Cat. No.	Colour
KEL50-C81NA	natural	KEL50-C81YE	yellow
KEL50-C81NY	neon-yellow	KEL50-C81BU	blue
KEL50-C81NB	neon-blue	KEL50-C81GR	green
KEL50-C81NG	neon-green	KEL50-C81RE	red
KEL50-C81NP	neon-red/pink	KEL50-C81VT	violet
KEL50-C81NO	neon-orange	KEL50-C81BL	black
KEL50-C81WH	white	KEL50-C81BB	black/black*

*black/black: Lower half and lid black for light-sensitive samples

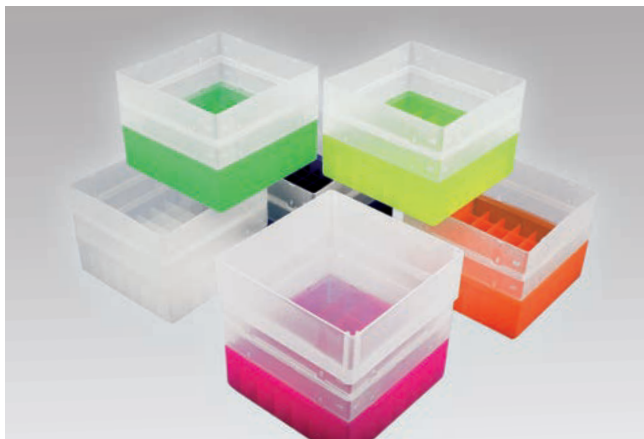

EPPi® 128 / 7x7 • height 128 mm fix

Inner height 125 mm. 7x7 divider holds for 49 tubes up to 17 mm Ø. Without ID code. (See also page 34: KEB128-CO49..).

Cat. No.	Colour	Cat. No.	Colour
KEA128-C49NA	natural	KEA128-C49YE	yellow
KEA128-C49NY	neon-yellow	KEA128-C49BU	blue
KEA128-C49NB	neon-blue	KEA128-C49GR	green
KEA128-C49NG	neon-green	KEA128-C49RE	red
KEA128-C49NP	neon-red/pink	KEA128-C49VT	violet
KEA128-C49NO	neon-orange	KEA128-C49BL	black
KEA128-C49WH	white	KEA128-C49BB	black/black*

*black/black: Lower half and lid black for light-sensitive samples



Our Speciality:

Drawer racks in German top quality.

Useful for EPPi® 45 + 50 and all boxes up to external dimensions 133x133x53 mm (WxDxH). Base of drawers closed. With folding handle. Width 140 mm. With and without safety stop. See also page 43.

Cat. No.	Bays Depth x Height	Dimensions DxH (mm)	With/Without Safety Stop
SE50-44NBOV	4 x 4	567x231	without
SE50-44NBMV	4 x 4	567x245	with
SE50-45NBOV	4 x 5	567x288	without
SE50-45NBMV	4 x 5	567x306	with
SE50-46NBOV	4 x 6	567x346	without
SE50-46NBMV	4 x 6	567x367	with

Matching Racks

Vertical Racks
page 39

Horizontal Racks
page 40-41

Drawer Racks
page 42-43

Upright Bins
page 47

Matching Racks

Vertical Racks
page 39

Horizontal Racks
page 40-41

Drawer Racks
page 42-43

Upright Bins
page 47

Matching Racks

Vertical Racks
page 39

Horizontal Racks
page 40-41

Drawer Racks
page 46

Upright Bins
page 47

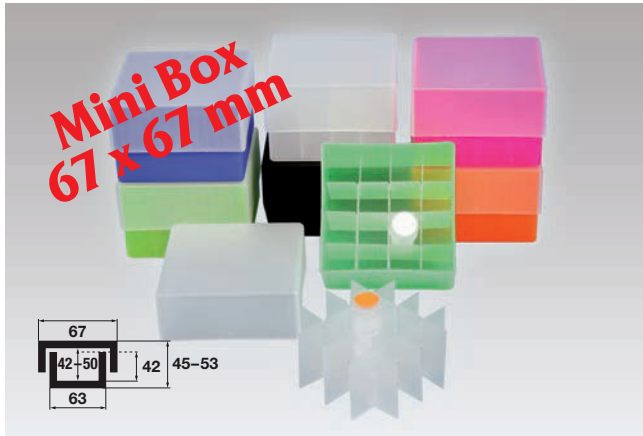

EPPi® 45 Junior • height 45–60 mm variable

Mini-Box with 67x67 mm outside dimensions incl. lid. Please select with or without grid divider. Other colours and grid dividers on request.

Cat. No.	Colour	Cat. No.	Colour
KEA45-VJxxNA	natural	KEA45-VJxxNP	neon-red/pink
KEA45-VJxxNY	neon-yellow	KEA45-VJxxNO	neon-orange
KEA45-VJxxNB	neon-blue	KEA45-VJxxBB	black/black*
KEA45-VJxxNG	neon-green		

↑ xx Please complete item number.

xx = 16 (4 x 4 compartments for tubes up to 14 mm Ø)

xx = 9 (3 x 3 compartments for tubes up to 20 mm Ø)

xx = 1 (Empty box without grid divider)

Additional grid dividers on request.

*black/black: Lower half and lid black for light-sensitive samples



EPPi® 32 / 12x12 • height 32 mm fix

12x12 conical holes for 144 PCR tubes 0.2 ml. Individual or strips. With alphanumeric ID code. Removable safety baseplate.

Cat. No.	Colour	Cat. No.	Colour
KEB32-CS144NA	natural	KEB32-CS144YE	yellow
KEB32-CS144NY	neon-yellow	KEB32-CS144BU	blue
KEB32-CS144NB	neon-blue	KEB32-CS144GR	green
KEB32-CS144NG	neon-green	KEB32-CS144RE	red
KEB32-CS144NP	neon-red/pink	KEB32-CS144VT	violet
KEB32-CS144NO	neon-orange	KEB32-CS144BL	black
KEB32-CS144WH	white	KEB32-CS144BB	black/black*

*black/black: Lower half and lid black for light-sensitive samples

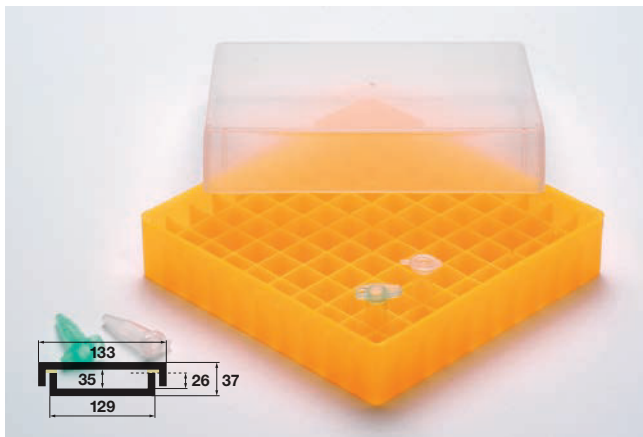

EPPi® 37 / 10x10 • height 37 mm fix

Inner height 35 mm. 10x10 divider holds tubes up to 11.4 mm Ø. Without ID code.

Cat. No.	Colour	Cat. No.	Colour
KEA37-C100NA	natural	KEA37-C100YE	yellow
KEA37-C100NY	neon-yellow	KEA37-C100BU	blue
KEA37-C100NB	neon-blue	KEA37-C100GR	green
KEA37-C100NG	neon-green	KEA37-C100RE	red
KEA37-C100NP	neon-red/pink	KEA37-C100VT	violet
KEA37-C100NO	neon-orange	KEA37-C100BL	black
KEA37-C100WH	white	KEA37-C100BB	black/black*

*black/black: Lower half and lid black for light-sensitive samples

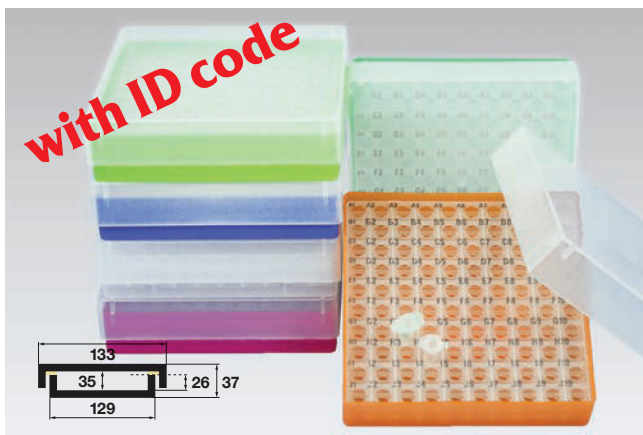

EPPi® 37 / 10x10 • height 37 mm fix

Inner height 35 mm. With two hole inserts 10x10 holes for 100 tubes 0.5 ml Safe-Lock® up to 8.5 mm Ø. With alphanumeric ID code.

Cat. No.	Colour	Cat. No.	Colour
KEB37-C0100NA	natural	KEB37-C0100YE	yellow
KEB37-C0100NY	neon-yellow	KEB37-C0100BU	blue
KEB37-C0100NB	neon-blue	KEB37-C0100GR	green
KEB37-C0100NG	neon-green	KEB37-C0100RE	red
KEB37-C0100NP	neon-red/pink	KEB37-C0100VT	violet
KEB37-C0100NO	neon-orange	KEB37-C0100BL	black
KEB37-C0100WH	white	KEB37-C0100BB	black/black*

*black/black: Lower half and lid black for light-sensitive samples

Matching Racks

Vertical Racks
Please request!

Horizontal Racks
Please request!

Drawer Racks
Please request!

Upright Bins
page 47

Matching Racks

Vertical Racks
page 39

Horizontal Racks
page 40–41

Drawer Racks
Please request!

Upright Bins
page 47

Matching Racks

Vertical Racks
page 39

Horizontal Racks
page 40–41

Drawer Racks
page 44

Upright Bins
page 47

Matching Racks

Vertical Racks
page 39

Horizontal Racks
page 40–41

Drawer Racks
page 44

Upright Bins
page 47

EPPi® 37 • height 37 mm fix

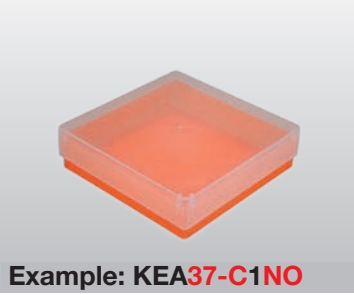

Inner heights: Lower section 26 mm, base to lid 35 mm.

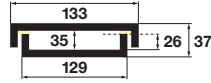

Example: KEA37-C1NO

Cat. No. KEA37-C1__

EPPi® 45 • height 45-53 mm variable

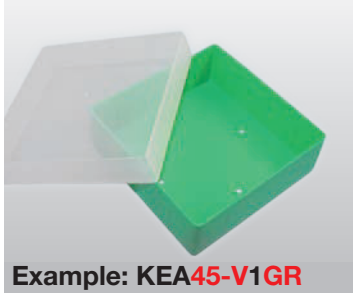

Inner heights: Lower section 42 mm, base to lid 42–50 mm.

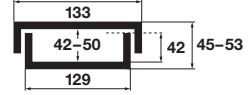

Example: KEA45-V1GR

Cat. No. KEA45-V1__

EPPi® 50 • height 52 mm fix

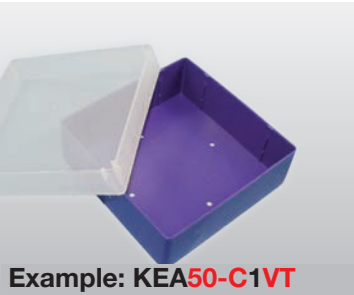

Inner heights: Lower section 42 mm, base to lid 50 mm.

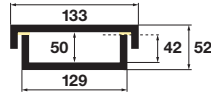

Example: KEA50-C1VT

Cat. No. KEA50-C1__

EPPi® 67 • height 67 mm fix

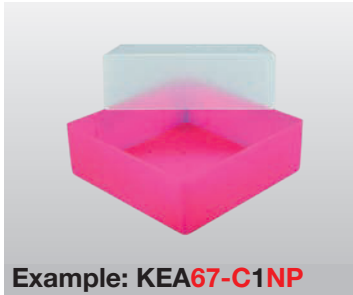

Inner height: Lower section 42 mm, base to lid 64 mm.

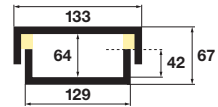

Example: KEA67-C1NP

Cat. No. KEA67-C1__

EPPi® 70 • height 70-80 mm variable

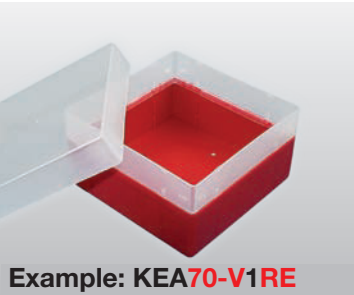

Inner heights: Lower section 67 mm, base to lid 67–77 mm.

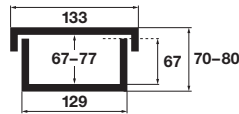

Example: KEA70-V1RE

Cat. No. KEA70-V1__

EPPi® 75 • height 75 mm fix

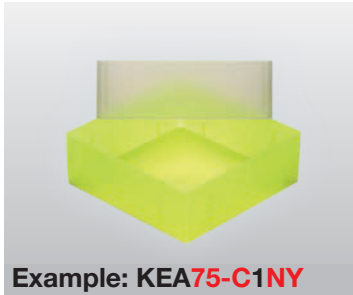

Inner height: Lower section 42 mm, base to lid 72 mm.

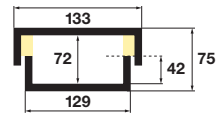

Example: KEA75-C1NY

Cat. No. KEA75-C1__

EPPi® 80 • height 80 mm fix

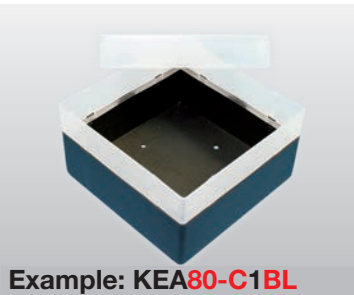

Inner heights: Lower section 67 mm, base to lid 77 mm.

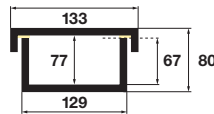

Example: KEA80-C1BL

Cat. No. KEA80-C1__

EPPi® 95 • height 95 mm fix



Inner height: Lower section 42 mm, base to lid 92 mm.

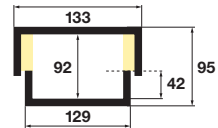

Example: KEA95-C1NO

Cat. No. KEA95-C1__

EPPi® 96 • height 96-106 mm variable

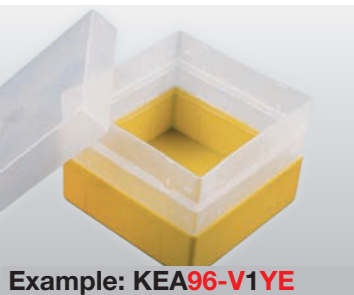

Inner heights: Lower section 92 mm, base to lid 92–103 mm.

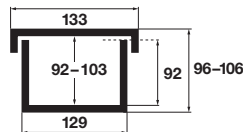

Example: KEA96-V1YE

Cat. No. KEA96-V1__

EPPi® 102 • height 102 mm fix

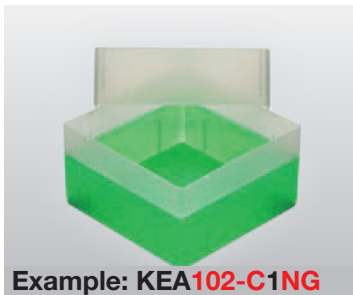

Inner height: Lower section 67 mm, base to lid 100 mm.

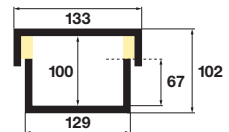

Example: KEA102-C1NG

Cat. No. KEA102-C1__

EPPi® 105 • height 105 mm fix

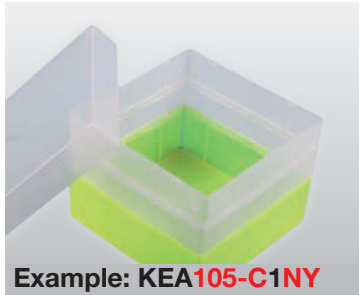

Inner heights: Lower section 92 mm, base to lid 102 mm.

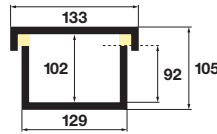

Example: KEA105-C1NY

Cat. No. KEA105-C1__

EPPi® 121 • height 121-131 mm variable



Inner heights: Lower section 118 mm, base to lid 118–128 mm.

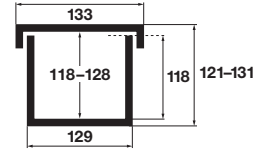

Example: KEA121-V1NP

Cat. No. KEA121-V1__

Cat. No.	Colour
KEAxx-x1NA	natural
KEAxx-x1NY	neon-yellow
KEAxx-x1NB	neon-blue
KEAxx-x1NG	neon-green
KEAxx-x1NP	neon-red/pink
KEAxx-x1NO	neon-orange
KEAxx-x1WH	white

Cat. No.	Colour
KEAxx-x1YE	yellow
KEAxx-x1BU	blue
KEAxx-x1GR	green
KEAxx-x1RE	red
KEAxx-x1VT	violet
KEAxx-x1BL	black
KEAxx-x1BB	black/black*

All boxes are suitable for EPPi hole inserts or grid dividers (Page 37) and are available in 13 different colours. Special colours on request. Please add the corresponding 2-digit colour code to the end of the item number.

*black/black: Lower half and lid black for light-sensitive samples

Matching Racks
 Vertical Racks page 39
 Horizontal Racks page 40–41
 Drawer Racks page 42–46
 Upright Bins page 47

EPPi® 122 • height 122 mm fix



Inner heights: Lower section 67 mm, base to lid 118 mm.

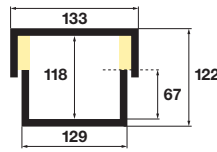

Example: KEA122-C1YE

Cat. No. KEA122-C1__

EPPi® 128 • height 128 mm fix

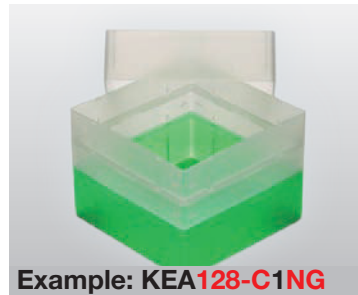

Inner heights: Lower section 92 mm, base to lid 125 mm.

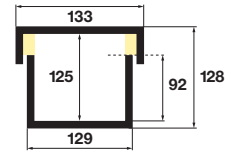

Example: KEA128-C1NG

Cat. No. KEA128-C1__

EPPi® 129 • height 129 mm fix



Inner heights: Lower section 117 mm, base to lid 126 mm. See also page 36.

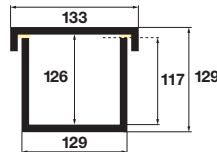

Example: KEA129-C1NA

Cat. No. KEA129-C1__

EPPi® 145 • height 145-155 mm variable

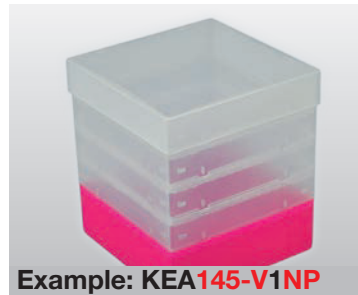

Inner heights: Lower section 142 mm, base to lid 142–152 mm. See also page 36.

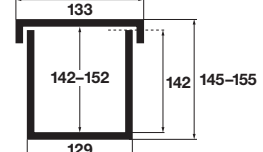

Example: KEA145-V1NP

Cat. No. KEA145-V1__

EPPi® 154 • height 154 mm fix



Inner heights: Lower section 142 mm, base to lid 151 mm. See also page 36.

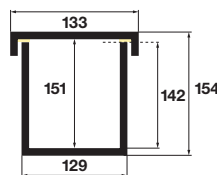

Example: KEA154-C1BU

Cat. No. KEA154-C1__

EPPi® 178 • height 178 mm fix



Inner heights: Lower section 142 mm, base to lid 175 mm. See also page 36.

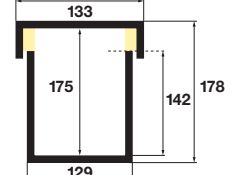

Example: KEA178-C1NO

Cat. No. KEA178-C1__

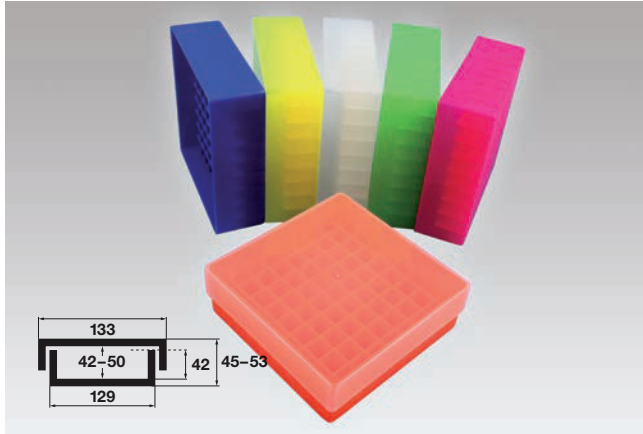

EPPi® 45 / 9x9 • height 45-53 mm variable

9x9 divider holds 81 tubes up to 12.5 mm Ø.
Without ID code. (See also page 14: KEA50..).

Cat. No.	Colour	Cat. No.	Colour
KEA45-V81NA	natural	KEA45-V81YE	yellow
KEA45-V81NY	neon-yellow	KEA45-V81BU	blue
KEA45-V81NB	neon-blue	KEA45-V81GR	green
KEA45-V81NG	neon-green	KEA45-V81RE	red
KEA45-V81NP	neon-red/pink	KEA45-V81VT	violet
KEA45-V81NO	neon-orange	KEA45-V81BL	black
KEA45-V81WH	white	KEA45-V81BB	black/black*

*black/black: Lower half and lid black for light-sensitive samples

Matching Racks

Vertical Racks
page 39
Horizontal Racks
page 40–41
Drawer Racks
page 42–43
Upright Bins
page 47

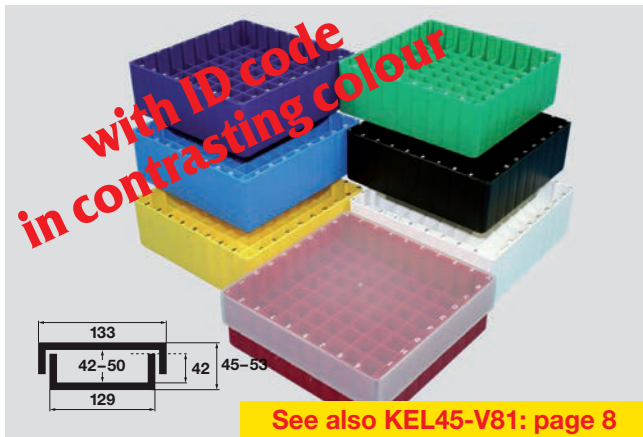

EPPi® 45 / 9x9 • height 45-53 mm variable

9x9 divider holds 81 tubes up to 12.5 mm Ø.
With alphanumeric ID code on all 4 sides.
(See also page 14: KEB50..).

Cat. No.	Colour	Cat. No.	Colour
KEB45-V81NA	natural	KEB45-V81YE	yellow
KEB45-V81NY	neon-yellow	KEB45-V81BU	blue
KEB45-V81NB	neon-blue	KEB45-V81GR	green
KEB45-V81NG	neon-green	KEB45-V81RE	red
KEB45-V81NP	neon-red/pink	KEB45-V81VT	violet
KEB45-V81NO	neon-orange	KEB45-V81BL	black
KEB45-V81WH	white	KEB45-V81BB	black/black*

*black/black: Lower half and lid black for light-sensitive samples

Matching Racks

Vertical Racks
page 39
Horizontal Racks
page 40–41
Drawer Racks
page 42–43
Upright Bins
page 47

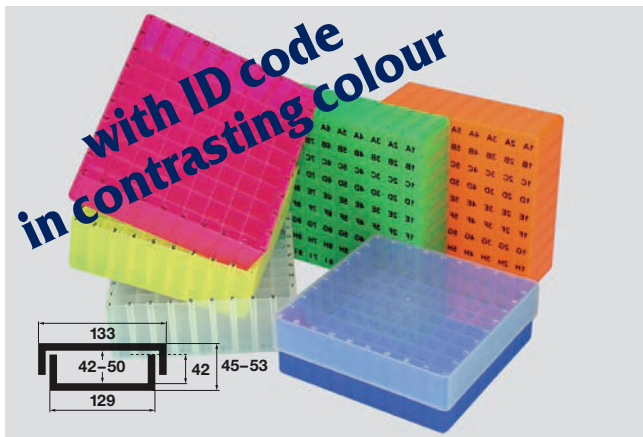

EPPi® 45 / 9x9 • height 45-53 mm variable

9x9 divider holds 81 tubes up to 12.5 mm Ø.
With alphanumeric ID code on all 4 sides as well as on the bottom of the box (transparent).
(See also page 14: KEC50..).

Cat. No.	Colour
KEC45-V81NA	natural
KEC45-V81NY	neon-yellow
KEC45-V81NB	neon-blue
KEC45-V81NG	neon-green
KEC45-V81NP	neon-red/pink
KEC45-V81NO	neon-orange

Matching Racks

Vertical Racks
page 39
Horizontal Racks
page 40–41
Drawer Racks
page 42–43
Upright Bins
page 47



EPPi® 45 / 9x9 • height 45-53 mm variable

9x9 divider holds 81 tubes up to 12.5 mm Ø.
With alphanumeric ID code on all 4 sides as well as on the bottom of the box (transparent) and on the lid.
(See also page 14: KEE50..).

Cat. No.	Colour
KEE45-V81NA	natural
KEE45-V81NY	neon-yellow
KEE45-V81NB	neon-blue
KEE45-V81NG	neon-green
KEE45-V81NP	neon-red/pink
KEE45-V81NO	neon-orange

Matching Racks

Vertical Racks
page 39
Horizontal Racks
page 40–41
Drawer Racks
page 42–43
Upright Bins
page 47

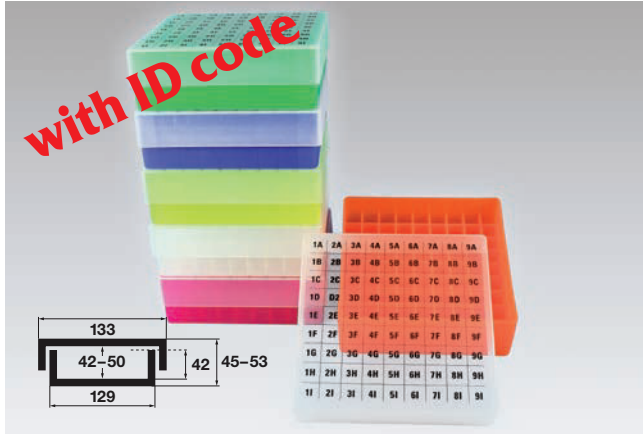

EPPi® 45 / 9x9 • height 45-53 mm variable

9x9 divider holds 81 tubes up to 12.5 mm Ø.
With alphanumeric ID code on the lid.
(See also page 15: KEH50..).

Cat. No.	Colour
KEH45-V81NA	natural
KEH45-V81NY	neon-yellow
KEH45-V81NB	neon-blue
KEH45-V81NG	neon-green
KEH45-V81NP	neon-red/pink
KEH45-V81NO	neon-orange
KEH45-V81RE	red

Matching Racks

Vertical Racks
page 39
Horizontal Racks
page 40–41
Drawer Racks
page 42–43
Upright Bins
page 47

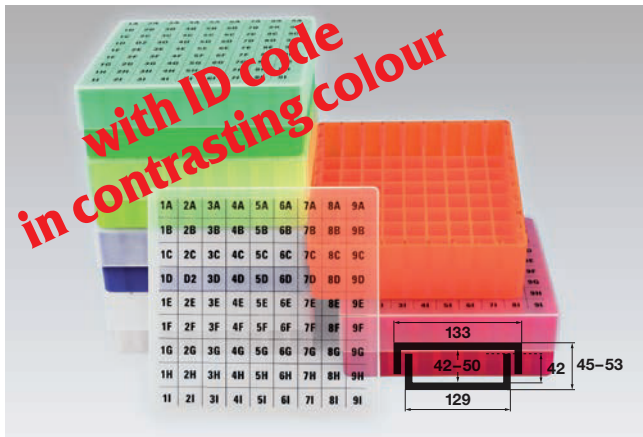

EPPi® 45 / 9x9 • height 45-53 mm variable

9x9 divider holds 81 tubes up to 12.5 mm Ø.
With alphanumeric ID code on all 4 sides as well as on the lid. (See also page 15: KEK50..).

Cat. No.	Colour
KEK45-V81NA	natural
KEK45-V81NY	neon-yellow
KEK45-V81NB	neon-blue
KEK45-V81NG	neon-green
KEK45-V81NP	neon-red/pink
KEK45-V81NO	neon-orange
KEK45-V81RE	red

Matching Racks

Vertical Racks
page 39
Horizontal Racks
page 40–41
Drawer Racks
page 42–43
Upright Bins
page 47



EPPi® 45 / 9x9 • height 45-53 mm variable

9x9 divider holds 81 tubes up to 12.5 mm Ø.
With numeric ID code (1-81) on the lid.
(See also page 15: KEM50..).

Cat. No.	Colour
KEM45-V81NA	natural
KEM45-V81NY	neon-yellow
KEM45-V81NB	neon-blue
KEM45-V81NG	neon-green
KEM45-V81NP	neon-red/pink
KEM45-V81NO	neon-orange
KEM45-V81RE	red

Matching Racks

Vertical Racks
page 39
Horizontal Racks
page 40–41
Drawer Racks
page 42–43
Upright Bins
page 47



EPPi® 45 / 9x9 • height 45-53 mm variable

9x9 divider holds 81 tubes up to 12.5 mm Ø.
With numeric ID code (1-81) on the bottom of the box (transparent) and on the lid.
(See also page 15: KER50..).

Cat. No.	Colour
KER45-V81NA	natural
KER45-V81NY	neon-yellow
KER45-V81NB	neon-blue
KER45-V81NG	neon-green
KER45-V81NP	neon-red/pink
KER45-V81NO	neon-orange

Matching Racks

Vertical Racks
page 39
Horizontal Racks
page 40–41
Drawer Racks
page 42–43
Upright Bins
page 47

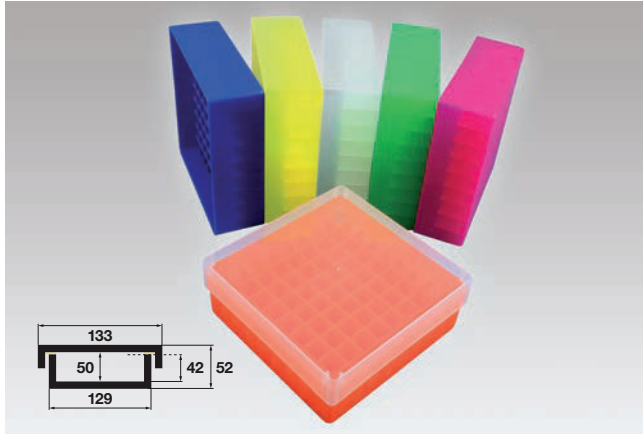

EPPi® 50 / 9x9 • height 52 mm fix

Inner height 50 mm. 9x9 divider holds 81 tubes up to 12.5 mm Ø. Without ID code. (See also page 12: KEA45..).

Cat. No.	Colour	Cat. No.	Colour
KEA50-C81NA	natural	KEA50-C81YE	yellow
KEA50-C81NY	neon-yellow	KEA50-C81BU	blue
KEA50-C81NB	neon-blue	KEA50-C81GR	green
KEA50-C81NG	neon-green	KEA50-C81RE	red
KEA50-C81NP	neon-red/pink	KEA50-C81VT	violet
KEA50-C81NO	neon-orange	KEA50-C81BL	black
KEA50-C81WH	white	KEA50-C81BB	black/black*

*black/black: Lower half and lid black for light-sensitive samples

Matching Racks

Vertical Racks
page 39
Horizontal Racks
page 40–41
Drawer Racks
page 42–43
Upright Bins
page 47

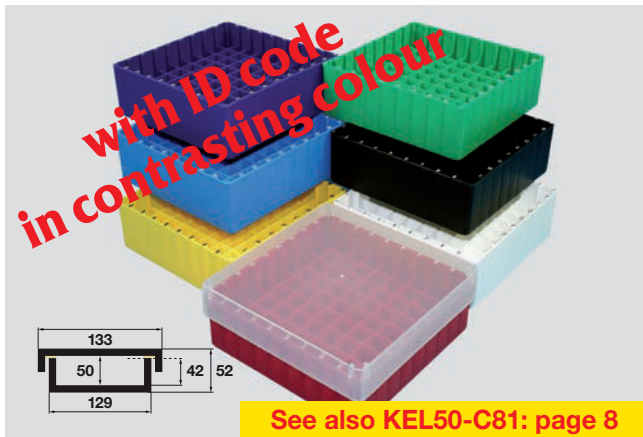

EPPi® 50 / 9x9 • height 52 mm fix

Inner height 50 mm. 9x9 divider holds 81 tubes up to 12.5 mm Ø. With alphanumeric ID code on all 4 sides. (See also page 12: KEB45..).

Cat. No.	Colour	Cat. No.	Colour
KEB50-C81NA	natural	KEB50-C81YE	yellow
KEB50-C81NY	neon-yellow	KEB50-C81BU	blue
KEB50-C81NB	neon-blue	KEB50-C81GR	green
KEB50-C81NG	neon-green	KEB50-C81RE	red
KEB50-C81NP	neon-red/pink	KEB50-C81VT	violet
KEB50-C81NO	neon-orange	KEB50-C81BL	black
KEB50-C81WH	white	KEB50-C81BB	black/black*

*black/black: Lower half and lid black for light-sensitive samples

Matching Racks

Vertical Racks
page 39
Horizontal Racks
page 40–41
Drawer Racks
page 42–43
Upright Bins
page 47

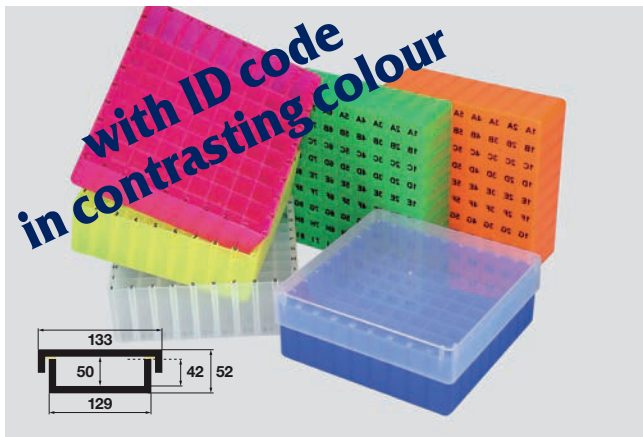

EPPi® 50 / 9x9 • height 52 mm fix

Inner height 50 mm. 9x9 divider holds 81 tubes up to 12.5 mm Ø. With alphanumeric ID code on all 4 sides as well as on the bottom (transparent). (See also page 12: KEC45..).

Cat. No.	Colour
KEC50-C81NA	natural
KEC50-C81NY	neon-yellow
KEC50-C81NB	neon-blue
KEC50-C81NG	neon-green
KEC50-C81NP	neon-red/pink
KEC50-C81NO	neon-orange

Matching Racks

Vertical Racks
page 39
Horizontal Racks
page 40–41
Drawer Racks
page 42–43
Upright Bins
page 47

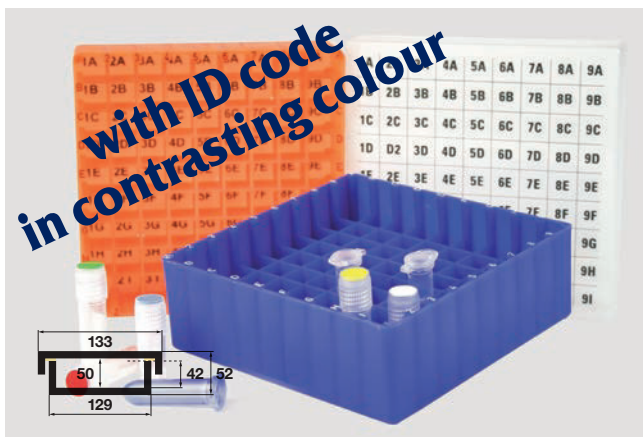

EPPi® 50 / 9x9 • height 52 mm fix

Inner height 50 mm. 9x9 divider holds 81 tubes up to 12.5 mm Ø. With alphanumeric ID code on all 4 sides as well as on the bottom (transparent) and on the lid. (See also page 12: KEE45..).

Cat. No.	Colour
KEE50-C81NA	natural
KEE50-C81NY	neon-yellow
KEE50-C81NB	neon-blue
KEE50-C81NG	neon-green
KEE50-C81NP	neon-red/pink
KEE50-C81NO	neon-orange

Matching Racks

Vertical Racks
page 39
Horizontal Racks
page 40–41
Drawer Racks
page 42–43
Upright Bins
page 47



EPPi® 50 / 9x9 • height 52 mm fix

Inner height 50 mm. 9x9 divider holds 81 tubes up to 12.5 mm Ø. With alphanumeric ID code on the lid. (See also page 13: KEH45..).

Cat. No.	Colour
KEH50-C81NA	natural
KEH50-C81NY	neon-yellow
KEH50-C81NB	neon-blue
KEH50-C81NG	neon-green
KEH50-C81NP	neon-red/pink
KEH50-C81NO	neon-orange
KEH50-C81RE	red

Matching Racks

Vertical Racks
page 39
Horizontal Racks
page 40–41
Drawer Racks
page 42–43
Upright Bins
page 47



EPPi® 50 / 9x9 • height 52 mm fix

Inner height 50 mm. 9x9 divider holds 81 tubes up to 12.5 mm Ø. With alphanumeric ID code on all 4 sides as well as on the lid. (See also page 13: KEK45..).

Cat. No.	Colour
KEK50-C81NA	natural
KEK50-C81NY	neon-yellow
KEK50-C81NB	neon-blue
KEK50-C81NG	neon-green
KEK50-C81NP	neon-red/pink
KEK50-C81NO	neon-orange
KEK50-C81RE	red

Matching Racks

Vertical Racks
page 39
Horizontal Racks
page 40–41
Drawer Racks
page 42–43
Upright Bins
page 47



EPPi® 50 / 9x9 • height 52 mm fix

Inner height 50 mm. 9x9 divider holds 81 tubes up to 12.5 mm Ø. With numeric ID code (1-81) on the lid. (See also page 13: KEM45..).

Cat. No.	Colour
KEM50-C81NA	natural
KEM50-C81NY	neon-yellow
KEM50-C81NB	neon-blue
KEM50-C81NG	neon-green
KEM50-C81NP	neon-red/pink
KEM50-C81NO	neon-orange
KEM50-C81RE	red

Matching Racks

Vertical Racks
page 39
Horizontal Racks
page 40–41
Drawer Racks
page 42–43
Upright Bins
page 47



EPPi® 50 / 9x9 • height 52 mm fix

Inner height 50 mm. 9x9 divider holds 81 tubes up to 12.5 mm Ø. With numeric ID code (1-81) on the bottom (transparent) and on the lid. (See also page 13: KER45..).

Cat. No.	Colour
KER50-C81NA	natural
KER50-C81NY	neon-yellow
KER50-C81NB	neon-blue
KER50-C81NG	neon-green
KER50-C81NP	neon-red/pink
KER50-C81NO	neon-orange

Matching Racks

Vertical Racks
page 39
Horizontal Racks
page 40–41
Drawer Racks
page 42–43
Upright Bins
page 47

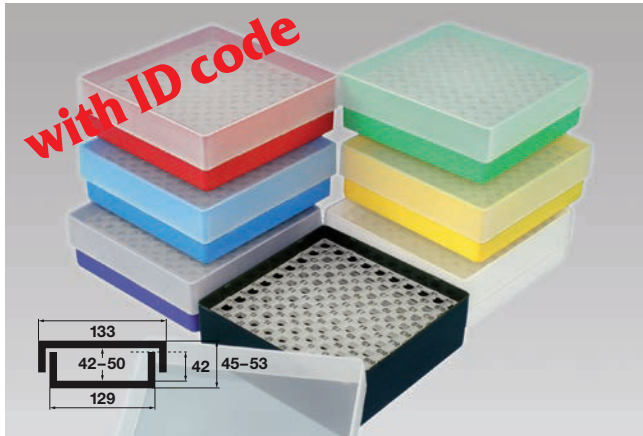

EPPi® 45 / 10x10 • height 45-53 mm variable

With two hole inserts 10x10 holes for 100 tubes up to 8.5 mm Ø. With alphanumeric ID code. (See also page 9: KEB37.. and page 14: KEB50..).

Cat. No.	Colour	Cat. No.	Colour
KEB45-V0100NA	natural	KEB45-V0100YE	yellow
KEB45-V0100NY	neon-yellow	KEB45-V0100BU	blue
KEB45-V0100NB	neon-blue	KEB45-V0100GR	green
KEB45-V0100NG	neon-green	KEB45-V0100RE	red
KEB45-V0100NP	neon-red/pink	KEB45-V0100VT	violet
KEB45-V0100NO	neon-orange	KEB45-V0100BL	black
KEB45-V0100WH	white	KEB45-V0100BB	black/black*

*black/black: Lower half and lid black for light-sensitive samples

Matching Racks

Vertical Racks
page 39
Horizontal Racks
page 40–41
Drawer Racks
page 42–43
Upright Bins
page 47



EPPi® 45 / 8x8 • height 45-53 mm variable

With two hole inserts 8x8 holes for 64 reaction vessels 1.5 and 2.0 ml Safe-Lock® up to 11 mm Ø. With alphanumeric ID code. (See also page 17: KEB50..).

Cat. No.	Colour	Cat. No.	Colour
KEB45-V064NA	natural	KEB45-V064YE	yellow
KEB45-V064NY	neon-yellow	KEB45-V064BU	blue
KEB45-V064NB	neon-blue	KEB45-V064GR	green
KEB45-V064NG	neon-green	KEB45-V064RE	red
KEB45-V064NP	neon-red/pink	KEB45-V064VT	violet
KEB45-V064NO	neon-orange	KEB45-V064BL	black
KEB45-V064WH	white	KEB45-V064BB	black/black*

*black/black: Lower half and lid black for light-sensitive samples

Matching Racks

Vertical Racks
page 39
Horizontal Racks
page 40–41
Drawer Racks
page 42–43
Upright Bins
page 47

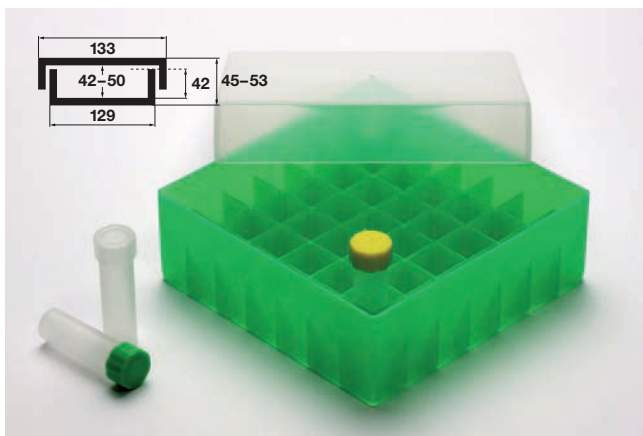

EPPi® 45 / 7x7 • height 45-53 mm variable

7x7 divider holds 49 tubes up to 17 mm Ø. Without ID code. (See also page 17: KEA50..).

Cat. No.	Colour	Cat. No.	Colour
KEA45-V49NA	natural	KEA45-V49YE	yellow
KEA45-V49NY	neon-yellow	KEA45-V49BU	blue
KEA45-V49NB	neon-blue	KEA45-V49GR	green
KEA45-V49NG	neon-green	KEA45-V49RE	red
KEA45-V49NP	neon-red/pink	KEA45-V49VT	violet
KEA45-V49NO	neon-orange	KEA45-V49BL	black
KEA45-V49WH	white	KEA45-V49BB	black/black*

*black/black: Lower half and lid black for light-sensitive samples

Matching Racks

Vertical Racks
page 39
Horizontal Racks
page 40–41
Drawer Racks
page 42–43
Upright Bins
page 47



EPPi® 45 / 7x7 • height 45-53 mm variable

With two hole inserts 7x7 holes for 49 tubes up to 16.5 mm Ø. With alphanumeric ID code. (See also page 17: KEB50..).

Cat. No.	Colour	Cat. No.	Colour
KEB45-V049NA	natural	KEB45-V049YE	yellow
KEB45-V049NY	neon-yellow	KEB45-V049BU	blue
KEB45-V049NB	neon-blue	KEB45-V049GR	green
KEB45-V049NG	neon-green	KEB45-V049RE	red
KEB45-V049NP	neon-red/pink	KEB45-V049VT	violet
KEB45-V049NO	neon-orange	KEB45-V049BL	black
KEB45-V049WH	white	KEB45-V049BB	black/black*

*black/black: Lower half and lid black for light-sensitive samples

Matching Racks

Vertical Racks
page 39
Horizontal Racks
page 40–41
Drawer Racks
page 42–43
Upright Bins
page 47

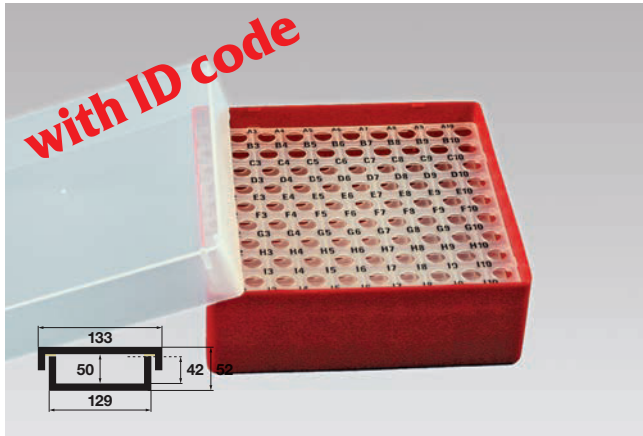

EPPi® 50 / 10x10 • height 52 mm fix

Inner height 50 mm. With two hole inserts 10x10 holes for tubes up to 8.5 mm Ø. With alphanumeric ID code. (See also page 9: KEB37.. and page 16: KEB45..).

Cat. No.	Colour	Cat. No.	Colour
KEB50-C0100NA	natural	KEB50-C0100YE	yellow
KEB50-C0100NY	neon-yellow	KEB50-C0100BU	blue
KEB50-C0100NB	neon-blue	KEB50-C0100GR	green
KEB50-C0100NG	neon-green	KEB50-C0100RE	red
KEB50-C0100NP	neon-red/pink	KEB50-C0100VT	violet
KEB50-C0100NO	neon-orange	KEB50-C0100BL	black
KEB50-C0100WH	white	KEB50-C0100BB	black/black*

*black/black: Lower half and lid black for light-sensitive samples

Matching Racks

Vertical Racks
page 39
Horizontal Racks
page 40–41
Drawer Racks
page 42–43
Upright Bins
page 47

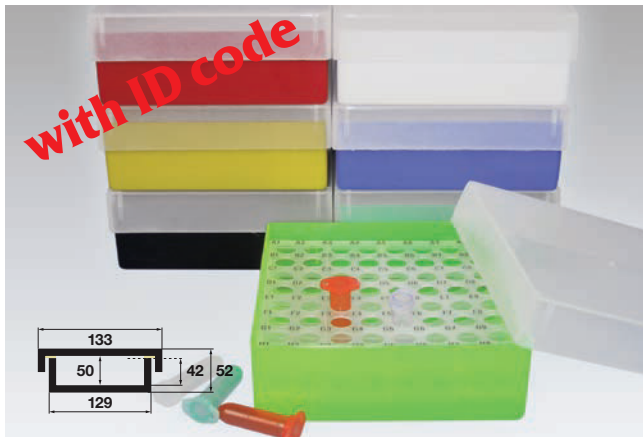

EPPi® 50 / 8x8 • height 52 mm fix

Inner height 50 mm. With two hole inserts 8x8 holes for 64 reaction vessels 1.5 and 2.0 ml Safe-Lock® up to 11 mm Ø. With alphanumeric ID code. (See also page 16: KEB45..).

Cat. No.	Colour	Cat. No.	Colour
KEB50-C064NA	natural	KEB50-C064YE	yellow
KEB50-C064NY	neon-yellow	KEB50-C064BU	blue
KEB50-C064NB	neon-blue	KEB50-C064GR	green
KEB50-C064NG	neon-green	KEB50-C064RE	red
KEB50-C064NP	neon-red/pink	KEB50-C064VT	violet
KEB50-C064NO	neon-orange	KEB50-C064BL	black
KEB50-C064WH	white	KEB50-C064BB	black/black*

*black/black: Lower half and lid black for light-sensitive samples

Matching Racks

Vertical Racks
page 39
Horizontal Racks
page 40–41
Drawer Racks
page 42–43
Upright Bins
page 47

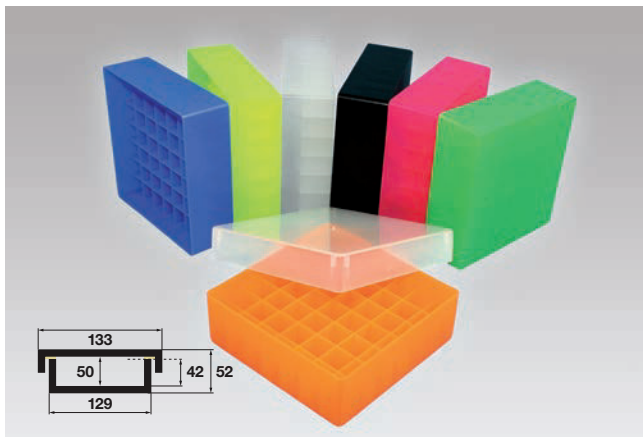

EPPi® 50 / 7x7 • height 52 mm fix

Inner height 50 mm. 7x7 divider holds 49 tubes up to 17 mm Ø. Without ID code. (See also page 16: KEA45..).

Cat. No.	Colour	Cat. No.	Colour
KEA50-C49NA	natural	KEA50-C49YE	yellow
KEA50-C49NY	neon-yellow	KEA50-C49BU	blue
KEA50-C49NB	neon-blue	KEA50-C49GR	green
KEA50-C49NG	neon-green	KEA50-C49RE	red
KEA50-C49NP	neon-red/pink	KEA50-C49VT	violet
KEA50-C49NO	neon-orange	KEA50-C49BL	black
KEA50-C49WH	white	KEA50-C49BB	black/black*

*black/black: Lower half and lid black for light-sensitive samples

Matching Racks

Vertical Racks
page 39
Horizontal Racks
page 40–41
Drawer Racks
page 42–43
Upright Bins
page 47

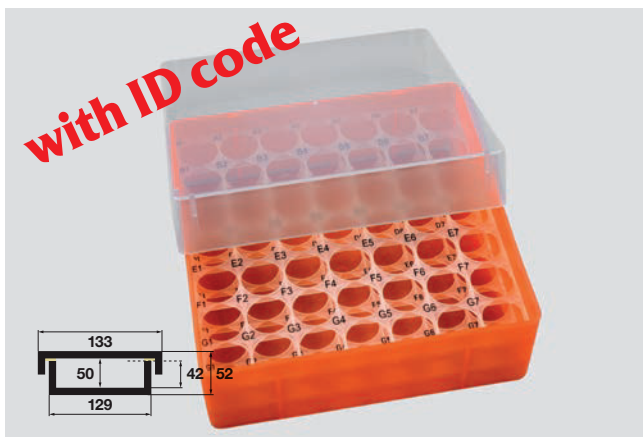

EPPi® 50 / 7x7 • height 52 mm fix

Inner height 50 mm. With two hole inserts 7x7 holes for 49 tubes up to 16.5 mm Ø. With alphanumeric ID code. (See also page 16: KEB45..).

Cat. No.	Colour	Cat. No.	Colour
KEB50-C049NA	natural	KEB50-C049YE	yellow
KEB50-C049NY	neon-yellow	KEB50-C049BU	blue
KEB50-C049NB	neon-blue	KEB50-C049GR	green
KEB50-C049NG	neon-green	KEB50-C049RE	red
KEB50-C049NP	neon-red/pink	KEB50-C049VT	violet
KEB50-C049NO	neon-orange	KEB50-C049BL	black
KEB50-C049WH	white	KEB50-C049BB	black/black*

*black/black: Lower half and lid black for light-sensitive samples

Matching Racks

Vertical Racks
page 39
Horizontal Racks
page 40–41
Drawer Racks
page 42–43
Upright Bins
page 47

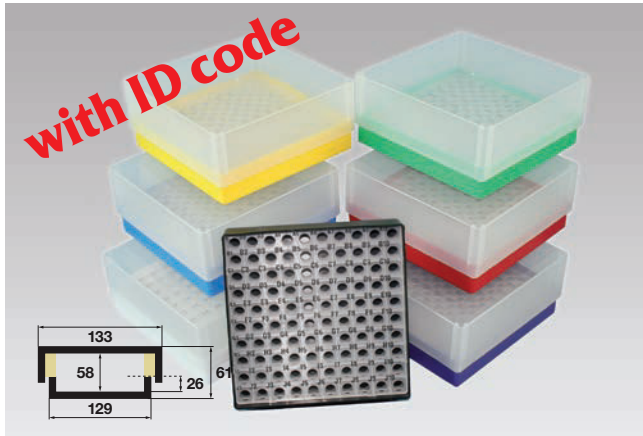

EPPi® 61 / 10x10 • height 61 mm fix

Inner height 58 mm. With two hole inserts 10x10 holes for 100 tubes up to 8.5 mm Ø. With alphanumeric ID code. (See also page 9: KEB37..., page 16: KEB45.. and page 17: KEB50..)

Cat. No.	Colour	Cat. No.	Colour
KEB61-C0100NA	natural	KEB61-C0100YE	yellow
KEB61-C0100NY	neon-yellow	KEB61-C0100BU	blue
KEB61-C0100NB	neon-blue	KEB61-C0100GR	green
KEB61-C0100NG	neon-green	KEB61-C0100RE	red
KEB61-C0100NP	neon-red/pink	KEB61-C0100VT	violet
KEB61-C0100NO	neon-orange	KEB61-C0100BL	black
KEB61-C0100WH	white	KEB61-C0100BB	black/black*

*black/black: Lower half and lid black for light-sensitive samples

Matching Racks

Vertical Racks
Please request!

Horizontal Racks
Please request!

Drawer Racks
Please request!

Upright Bins
page 47

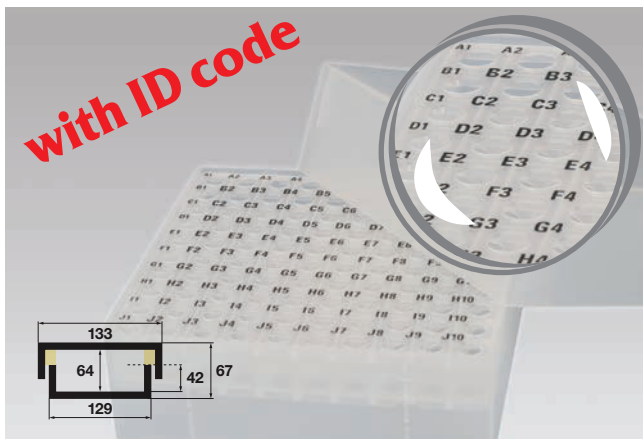

EPPi® 67 / 10x10 • height 67 mm fix

Inner height 64 mm. With two hole inserts 10x10 holes for 100 tubes up to 8.5 mm Ø. With alphanumeric ID code.

Cat. No.	Colour	Cat. No.	Colour
KEB67-C0100NA	natural	KEB67-C0100YE	yellow
KEB67-C0100NY	neon-yellow	KEB67-C0100BU	blue
KEB67-C0100NB	neon-blue	KEB67-C0100GR	green
KEB67-C0100NG	neon-green	KEB67-C0100RE	red
KEB67-C0100NP	neon-red/pink	KEB67-C0100VT	violet
KEB67-C0100NO	neon-orange	KEB67-C0100BL	black
KEB67-C0100WH	white	KEB67-C0100BB	black/black*

*black/black: Lower half and lid black for light-sensitive samples

Matching Racks

Vertical Racks
Please request!

Horizontal Racks
Please request!

Drawer Racks
Please request!

Upright Bins
page 47



EPPi® 67 / 8x8 • height 67 mm fix

Inner height 64 mm. With two hole inserts 8x8 holes for 64 tubes up to 11 mm Ø. With alphanumeric ID code.

Cat. No.	Colour	Cat. No.	Colour
KEB67-C064NA	natural	KEB67-C064YE	yellow
KEB67-C064NY	neon-yellow	KEB67-C064BU	blue
KEB67-C064NB	neon-blue	KEB67-C064GR	green
KEB67-C064NG	neon-green	KEB67-C064RE	red
KEB67-C064NP	neon-red/pink	KEB67-C064VT	violet
KEB67-C064NO	neon-orange	KEB67-C064BL	black
KEB67-C064WH	white	KEB67-C064BB	black/black*

*black/black: Lower half and lid black for light-sensitive samples

Matching Racks

Vertical Racks
Please request!

Horizontal Racks
Please request!

Drawer Racks
Please request!

Upright Bins
page 47

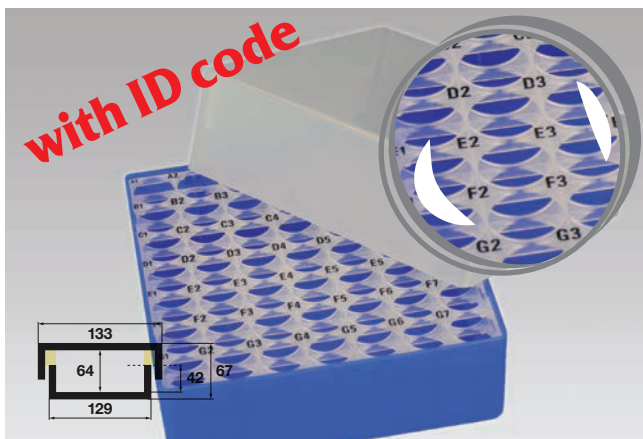

EPPi® 67 / 7x7 • height 67 mm fix

Inner height 64 mm. With two hole inserts 7x7 holes for 49 tubes up to 16.5 mm Ø. With alphanumeric ID code.

Cat. No.	Colour	Cat. No.	Colour
KEB67-C049NA	natural	KEB67-C049YE	yellow
KEB67-C049NY	neon-yellow	KEB67-C049BU	blue
KEB67-C049NB	neon-blue	KEB67-C049GR	green
KEB67-C049NG	neon-green	KEB67-C049RE	red
KEB67-C049NP	neon-red/pink	KEB67-C049VT	violet
KEB67-C049NO	neon-orange	KEB67-C049BL	black
KEB67-C049WH	white	KEB67-C049BB	black/black*

*black/black: Lower half and lid black for light-sensitive samples

Matching Racks

Vertical Racks
Please request!

Horizontal Racks
Please request!

Drawer Racks
Please request!

Upright Bins
page 47



EPPi® 67 / 5x5 • height 67 mm fix

Inner height 64 mm. With two hole inserts 5x5 holes for 25 reaction vessels or centrifuge tubes 5 ml and tubes up to 16.6 mm Ø. With numeric ID code. Alphanumeric ID code on request.

Cat. No.	Colour	Cat. No.	Colour
KES67-C025NA	natural	KES67-C025YE	yellow
KES67-C025NY	neon-yellow	KES67-C025BU	blue
KES67-C025NB	neon-blue	KES67-C025GR	green
KES67-C025NG	neon-green	KES67-C025RE	red
KES67-C025NP	neon-red/pink	KES67-C025VT	violet
KES67-C025NO	neon-orange	KES67-C025BL	black
KES67-C025WH	white	KES67-C025BB	black/black*

*black/black: Lower half and lid black for light-sensitive samples

Matching Racks

Vertical Racks
Please request!

Horizontal Racks
Please request!

Drawer Racks
Please request!

Upright Bins

page 47



EPPi® Ident Identification Tags

Identification tags for marking stainless steel racks and drawers according to customer requirements on request.



EPPi® 70 / 10x10 • height 70–80 mm variable

With two hole inserts 10x10 holes for 100 tubes up to 8.5 mm Ø. With alphanumeric ID code.

Cat. No.	Colour	Cat. No.	Colour
KEB70-V0100NA	natural	KEB70-V0100YE	yellow
KEB70-V0100NY	neon-yellow	KEB70-V0100BU	blue
KEB70-V0100NB	neon-blue	KEB70-V0100GR	green
KEB70-V0100NG	neon-green	KEB70-V0100RE	red
KEB70-V0100NP	neon-red/pink	KEB70-V0100VT	violet
KEB70-V0100NO	neon-orange	KEB70-V0100BL	black
KEB70-V0100WH	white	KEB70-V0100BB	black/black*

*black/black: Lower half and lid black for light-sensitive samples

Matching Racks

Vertical Racks
page 39

Horizontal Racks
page 40–41

Drawer Racks
page 44

Upright Bins
page 47

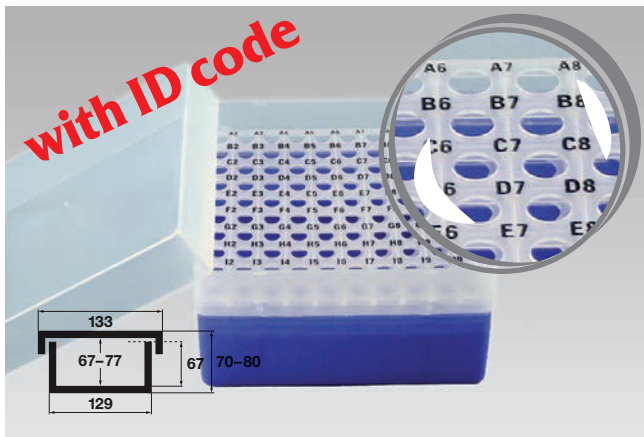

EPPi® 70 / 9x9 • height 70–80 mm variable

9x9 divider holds 81 tubes up to 12.5 mm Ø. Without ID code.

Cat. No.	Colour	Cat. No.	Colour
KEA70-V81NA	natural	KEA70-V81YE	yellow
KEA70-V81NY	neon-yellow	KEA70-V81BU	blue
KEA70-V81NB	neon-blue	KEA70-V81GR	green
KEA70-V81NG	neon-green	KEA70-V81RE	red
KEA70-V81NP	neon-red/pink	KEA70-V81VT	violet
KEA70-V81NO	neon-orange	KEA70-V81BL	black
KEA70-V81WH	white	KEA70-V81BB	black/black*

*black/black: Lower half and lid black for light-sensitive samples

Matching Racks

Vertical Racks
page 39

Horizontal Racks
page 40–41

Drawer Racks
page 44

Upright Bins
page 47

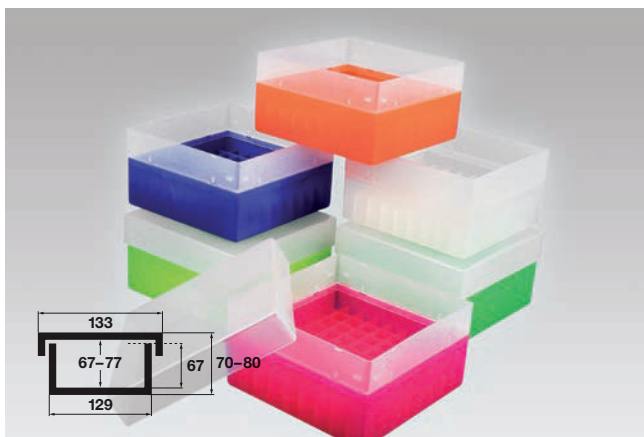

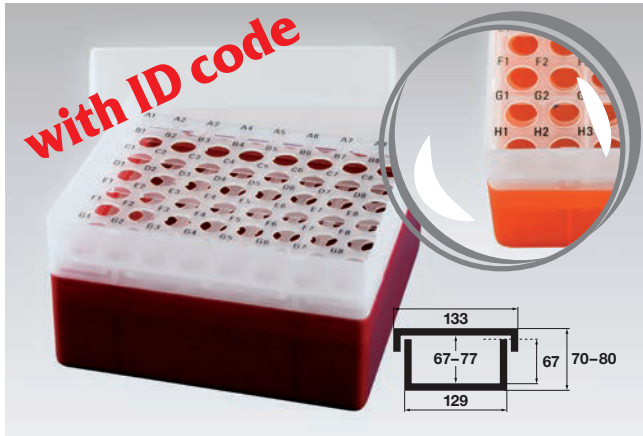

EPPi® 70 / 8x8 • height 70–80 mm variable

With two hole inserts 8x8 holes for 64 tubes up to 11 mm Ø. With alphanumeric ID code.

Cat. No.	Colour	Cat. No.	Colour
KEB70-V064NA	natural	KEB70-V064YE	yellow
KEB70-V064NY	neon-yellow	KEB70-V064BU	blue
KEB70-V064NB	neon-blue	KEB70-V064GR	green
KEB70-V064NG	neon-green	KEB70-V064RE	red
KEB70-V064NP	neon-red/pink	KEB70-V064VT	violet
KEB70-V064NO	neon-orange	KEB70-V064BL	black
KEB70-V064WH	white	KEB70-V064BB	black/black*

*black/black: Lower half and lid black for light-sensitive samples

Matching Racks

Vertical Racks
page 39
Horizontal Racks
page 40–41
Drawer Racks
page 44
Upright Bins
page 47

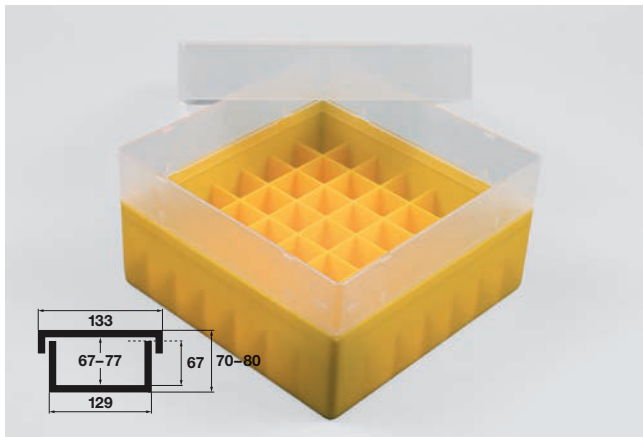

EPPi® 70 / 7x7 • height 70–80 mm variable

7x7 divider holds 49 tubes up to 17 mm Ø. Without ID code.

Cat. No.	Colour	Cat. No.	Colour
KEA70-V49NA	natural	KEA70-V49YE	yellow
KEA70-V49NY	neon-yellow	KEA70-V49BU	blue
KEA70-V49NB	neon-blue	KEA70-V49GR	green
KEA70-V49NG	neon-green	KEA70-V49RE	red
KEA70-V49NP	neon-red/pink	KEA70-V49VT	violet
KEA70-V49NO	neon-orange	KEA70-V49BL	black
KEA70-V49WH	white	KEA70-V49BB	black/black*

*black/black: Lower half and lid black for light-sensitive samples

Matching Racks

Vertical Racks
page 39
Horizontal Racks
page 40–41
Drawer Racks
page 44
Upright Bins
page 47

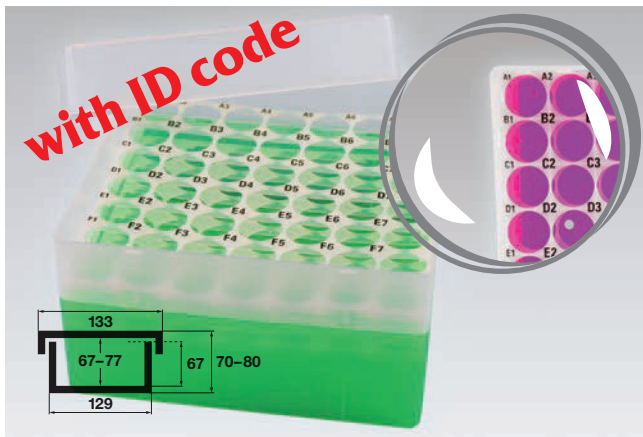

EPPi® 70 / 7x7 • height 70–80 mm variable

With two hole inserts 7x7 holes for 49 tubes up to 16.5 mm Ø. With alphanumeric ID code.

Cat. No.	Colour	Cat. No.	Colour
KEB70-V049NA	natural	KEB70-V049YE	yellow
KEB70-V049NY	neon-yellow	KEB70-V049BU	blue
KEB70-V049NB	neon-blue	KEB70-V049GR	green
KEB70-V049NG	neon-green	KEB70-V049RE	red
KEB70-V049NP	neon-red/pink	KEB70-V049VT	violet
KEB70-V049NO	neon-orange	KEB70-V049BL	black
KEB70-V049WH	white	KEB70-V049BB	black/black*

*black/black: Lower half and lid black for light-sensitive samples

Matching Racks

Vertical Racks
page 39
Horizontal Racks
page 40–41
Drawer Racks
page 44
Upright Bins
page 47



EPPi® 70 / 5x5 • height 70–80 mm variable

With two hole inserts 5x5 holes for 25 reaction vessels and tubes up to 16.6 mm Ø. With numeric ID code. Alphanumeric ID code on request. (See also page 19: KES67..).

Cat. No.	Colour	Cat. No.	Colour
KES70-V025NA	natural	KES70-V025YE	yellow
KES70-V025NY	neon-yellow	KES70-V025BU	blue
KES70-V025NB	neon-blue	KES70-V025GR	green
KES70-V025NG	neon-green	KES70-V025RE	red
KES70-V025NP	neon-red/pink	KES70-V025VT	violet
KES70-V025NO	neon-orange	KES70-V025BL	black
KES70-V025WH	white	KES70-V025BB	black/black*

*black/black: Lower half and lid black for light-sensitive samples

Matching Racks

Vertical Racks
page 39
Horizontal Racks
page 40–41
Drawer Racks
page 44
Upright Bins
page 47

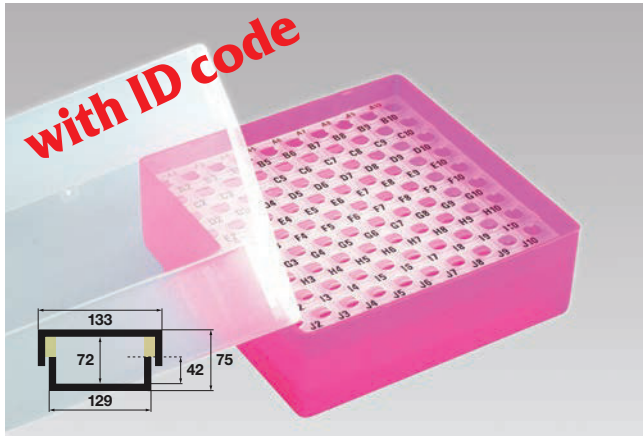

EPPi® 75 / 10x10 • height 75 mm fix

Inner height 72 mm. With two hole inserts
10x10 holes for 100 tubes up to 8.5 mm Ø.
With alphanumeric ID code.

Cat. No.	Colour	Cat. No.	Colour
KEB75-C0100NA	natural	KEB75-C0100YE	yellow
KEB75-C0100NY	neon-yellow	KEB75-C0100BU	blue
KEB75-C0100NB	neon-blue	KEB75-C0100GR	green
KEB75-C0100NG	neon-green	KEB75-C0100RE	red
KEB75-C0100NP	neon-red/pink	KEB75-C0100VT	violet
KEB75-C0100NO	neon-orange	KEB75-C0100BL	black
KEB75-C0100WH	white	KEB75-C0100BB	black/black*

*black/black: Lower half and lid black for light-sensitive samples

Matching Racks

Vertical Racks
page 39
Horizontal Racks
page 40–41
Drawer Racks
page 44
Upright Bins
page 47

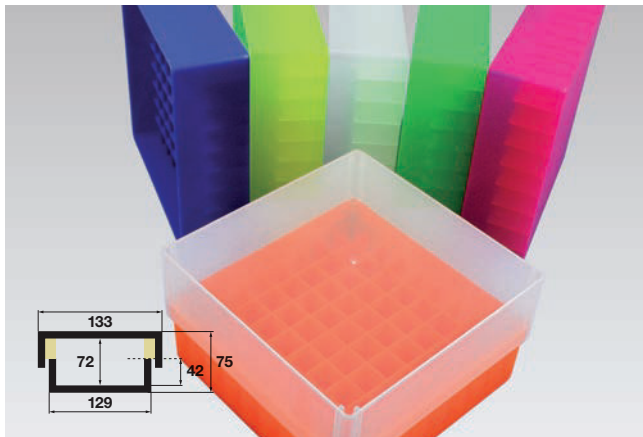

EPPi® 75 / 9x9 • height 75 mm fix

Inner height 72 mm. 9x9 divider holds 81 tubes
up to 12.5 mm Ø. Without ID code.

Cat. No.	Colour	Cat. No.	Colour
KEA75-C81NA	natural	KEA75-C81YE	yellow
KEA75-C81NY	neon-yellow	KEA75-C81BU	blue
KEA75-C81NB	neon-blue	KEA75-C81GR	green
KEA75-C81NG	neon-green	KEA75-C81RE	red
KEA75-C81NP	neon-red/pink	KEA75-C81VT	violet
KEA75-C81NO	neon-orange	KEA75-C81BL	black
KEA75-C81WH	white	KEA75-C81BB	black/black*

*black/black: Lower half and lid black for light-sensitive samples

Matching Racks

Vertical Racks
page 39
Horizontal Racks
page 40–41
Drawer Racks
page 44
Upright Bins
page 47

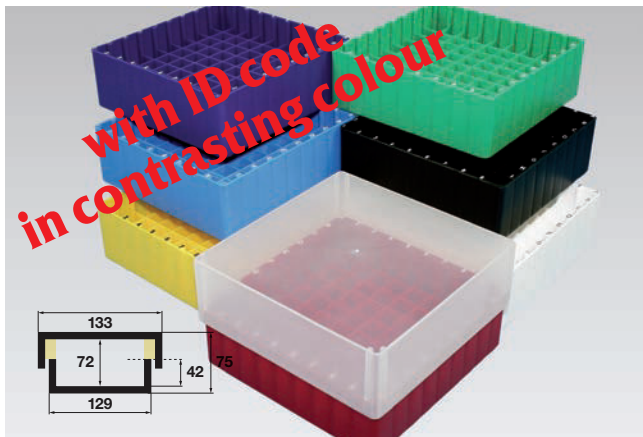

EPPi® 75 / 9x9 • height 75 mm fix

Inner height 72 mm. 9x9 divider holds 81 tubes
up to 12.5 mm Ø. With alphanumeric ID code on all
4 sides.

Cat. No.	Colour	Cat. No.	Colour
KEB75-C81NA	natural	KEB75-C81YE	yellow
KEB75-C81NY	neon-yellow	KEB75-C81BU	blue
KEB75-C81NB	neon-blue	KEB75-C81GR	green
KEB75-C81NG	neon-green	KEB75-C81RE	red
KEB75-C81NP	neon-red/pink	KEB75-C81VT	violet
KEB75-C81NO	neon-orange	KEB75-C81BL	black
KEB75-C81WH	white	KEB75-C81BB	black/black*

*black/black: Lower half and lid black for light-sensitive samples

Matching Racks

Vertical Racks
page 39
Horizontal Racks
page 40–41
Drawer Racks
page 44
Upright Bins
page 47

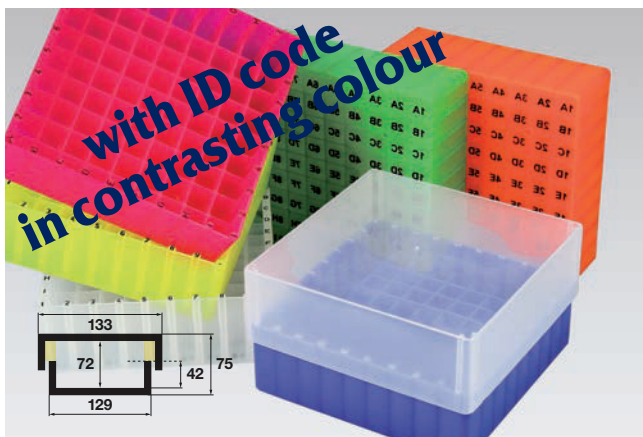

EPPi® 75 / 9x9 • height 75 mm fix

Inner height 72 mm. 9x9 divider holds 81 tubes
up to 12.5 mm Ø. With alphanumeric ID code
on all 4 sides as well as on the bottom of the box
(transparent).

Cat. No.	Colour
KEC75-C81NA	natural
KEC75-C81NY	neon-yellow
KEC75-C81NB	neon-blue
KEC75-C81NG	neon-green
KEC75-C81NP	neon-red/pink
KEC75-C81NO	neon-orange

Matching Racks

Vertical Racks
page 39
Horizontal Racks
page 40–41
Drawer Racks
page 44
Upright Bins
page 47

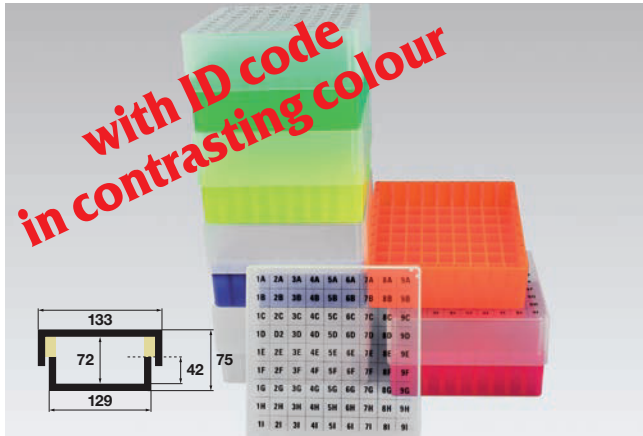

EPPi® 75 / 9x9 • height 75 mm fix

Inner height 72 mm. 9x9 divider holds 81 tubes up to 12.5 mm Ø. With alphanumeric ID code on all 4 sides as well as on the bottom of the box (transparent) and on the lid.

Cat. No.	Colour
KEE75-C81NA	natural
KEE75-C81NY	neon-yellow
KEE75-C81NB	neon-blue
KEE75-C81NG	neon-green
KEE75-C81NP	neon-red/pink
KEE75-C81NO	neon-orange

Matching Racks

Vertical Racks
page 39
Horizontal Racks
page 40–41
Drawer Racks
page 44
Upright Bins
page 47

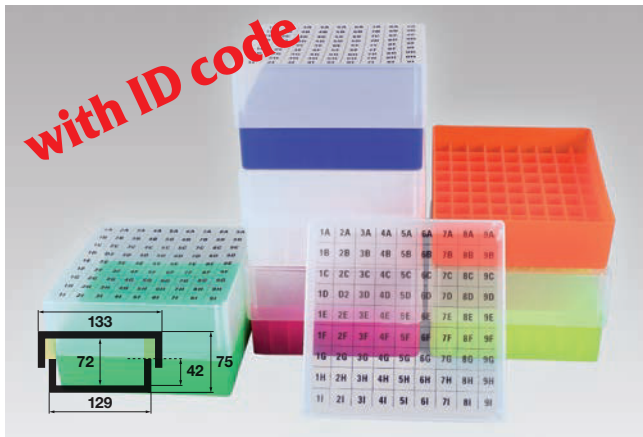

EPPi® 75 / 9x9 • height 75 mm fix

Inner height 72 mm. 9x9 divider holds 81 tubes up to 12.5 mm Ø. With alphanumeric ID code on the lid.

Cat. No.	Colour
KEH75-C81NA	natural
KEH75-C81NY	neon-yellow
KEH75-C81NB	neon-blue
KEH75-C81NG	neon-green
KEH75-C81NP	neon-red/pink
KEH75-C81NO	neon-orange
KEH75-C81RE	red

Matching Racks

Vertical Racks
page 39
Horizontal Racks
page 40–41
Drawer Racks
page 44
Upright Bins
page 47

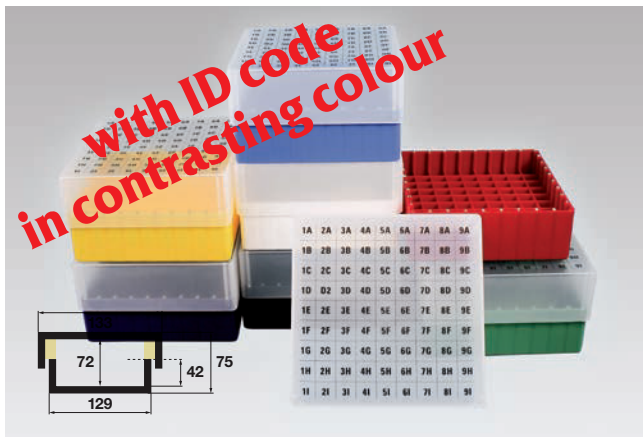

EPPi® 75 / 9x9 • height 75 mm fix

Inner height 72 mm. 9x9 divider holds 81 tubes up to 12.5 mm Ø. With alphanumeric ID code on all 4 sides and on the lid.

Cat. No.	Colour
KEK75-C81NA	natural
KEK75-C81NY	neon-yellow
KEK75-C81NB	neon-blue
KEK75-C81NG	neon-green
KEK75-C81NP	neon-red/pink
KEK75-C81NO	neon-orange
KEK75-C81RE	red

Matching Racks

Vertical Racks
page 39
Horizontal Racks
page 40–41
Drawer Racks
page 44
Upright Bins
page 47

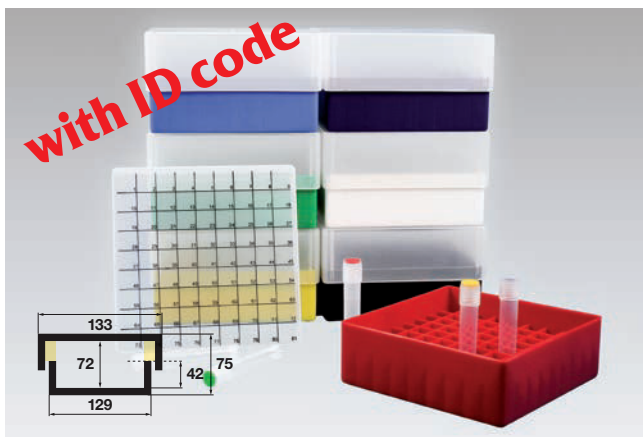

EPPi® 75 / 9x9 • height 75 mm fix

Inner height 72 mm. 9x9 divider holds 81 tubes up to 12.5 mm Ø. With numeric ID code (1–81) on the lid.

Cat. No.	Colour
KEM75-C81NA	natural
KEM75-C81NY	neon-yellow
KEM75-C81NB	neon-blue
KEM75-C81NG	neon-green
KEM75-C81NP	neon-red/pink
KEM75-C81NO	neon-orange
KEM75-C81RE	red

Matching Racks

Vertical Racks
page 39
Horizontal Racks
page 40–41
Drawer Racks
page 44
Upright Bins
page 47



EPPi® 75 / 9x9 • height 75 mm fix

Inner height 72 mm. 9x9 divider holds 81 tubes up to 12.5 mm Ø. With numeric ID code (1–81) on the bottom of the box (transparent) and on the lid.

Cat. No.	Colour
KER75-C81NA	natural
KER75-C81NY	neon-yellow
KER75-C81NB	neon-blue
KER75-C81NG	neon-green
KER75-C81NP	neon-red/pink
KER75-C81NO	neon-orange

Matching Racks

Vertical Racks
page 39
Horizontal Racks
page 40–41
Drawer Racks
page 44
Upright Bins
page 47

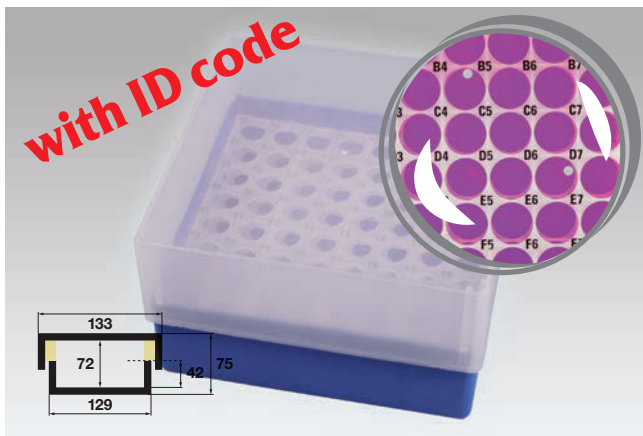

EPPi® 75 / 8x8 • height 75 mm fix

Inner height 72 mm. With two hole inserts 8x8 holes for 64 tubes up to 11 mm Ø. With alphanumeric ID code.

Cat. No.	Colour	Cat. No.	Colour
KEB75-C064NA	natural	KEB75-C064YE	yellow
KEB75-C064NY	neon-yellow	KEB75-C064BU	blue
KEB75-C064NB	neon-blue	KEB75-C064GR	green
KEB75-C064NG	neon-green	KEB75-C064RE	red
KEB75-C064NP	neon-red/pink	KEB75-C064VT	violet
KEB75-C064NO	neon-orange	KEB75-C064BL	black
KEB75-C064WH	white	KEB75-C064BB	black/black*

*black/black: Lower half and lid black for light-sensitive samples

Matching Racks

Vertical Racks
page 39
Horizontal Racks
page 40–41
Drawer Racks
page 44
Upright Bins
page 47

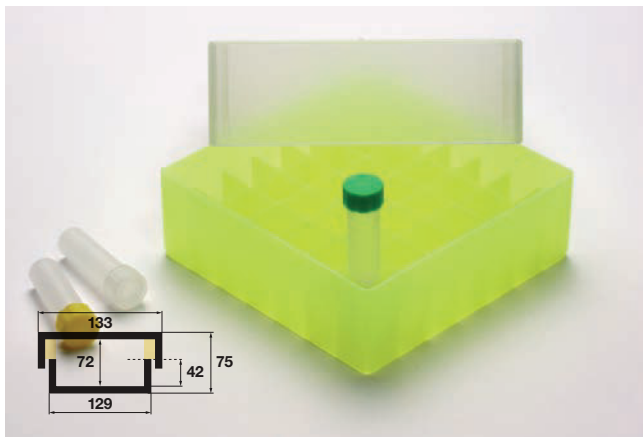

EPPi® 75 / 7x7 • height 75 mm fix

Inner height 72 mm. 7x7 divider holds 49 tubes up to 17 mm Ø. Without ID code.

Cat. No.	Colour	Cat. No.	Colour
KEA75-C49NA	natural	KEA75-C49YE	yellow
KEA75-C49NY	neon-yellow	KEA75-C49BU	blue
KEA75-C49NB	neon-blue	KEA75-C49GR	green
KEA75-C49NG	neon-green	KEA75-C49RE	red
KEA75-C49NP	neon-red/pink	KEA75-C49VT	violet
KEA75-C49NO	neon-orange	KEA75-C49BL	black
KEA75-C49WH	white	KEA75-C49BB	black/black*

*black/black: Lower half and lid black for light-sensitive samples

Matching Racks

Vertical Racks
page 39
Horizontal Racks
page 40–41
Drawer Racks
page 44
Upright Bins
page 47

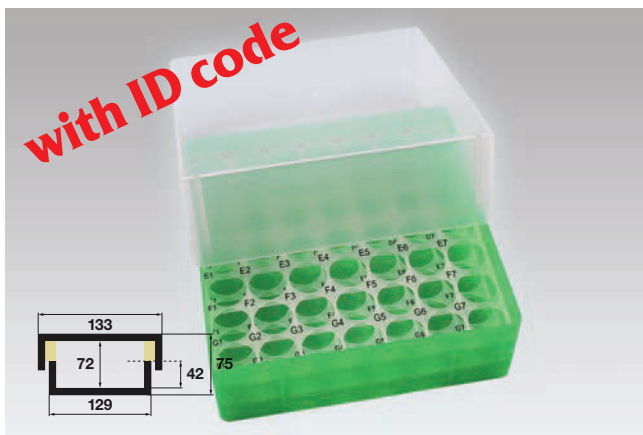

EPPi® 75 / 7x7 • height 75 mm fix

Inner height 72 mm. With two hole inserts 7x7 holes for 49 tubes up to 16.5 mm Ø. With alphanumeric ID code.

Cat. No.	Colour	Cat. No.	Colour
KEB75-C049NA	natural	KEB75-C049YE	yellow
KEB75-C049NY	neon-yellow	KEB75-C049BU	blue
KEB75-C049NB	neon-blue	KEB75-C049GR	green
KEB75-C049NG	neon-green	KEB75-C049RE	red
KEB75-C049NP	neon-red/pink	KEB75-C049VT	violet
KEB75-C049NO	neon-orange	KEB75-C049BL	black
KEB75-C049WH	white	KEB75-C049BB	black/black*

*black/black: Lower half and lid black for light-sensitive samples

Matching Racks

Vertical Racks
page 39
Horizontal Racks
page 40–41
Drawer Racks
page 44
Upright Bins
page 47

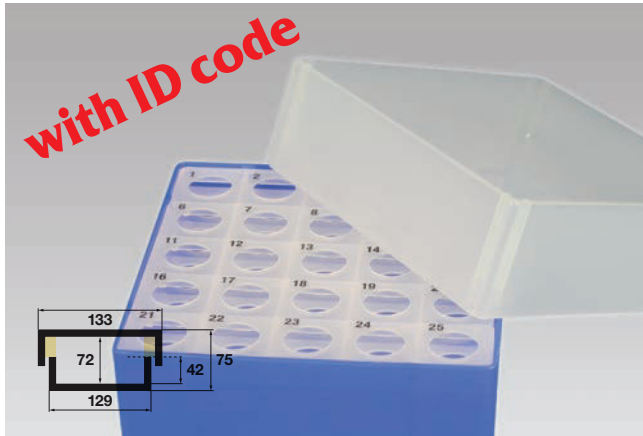

EPPi® 75 / 5x5 • height 75 mm fix

Inner height 72 mm. With two hole inserts 5x5 holes for 25 reaction vessels and tubes up to 16.6 mm Ø. With numeric ID code. Alphanumeric ID code on request. (See also page 19: KES67..).

Cat. No.	Colour	Cat. No.	Colour
KES75-C025NA	natural	KES75-C025YE	yellow
KES75-C025NY	neon-yellow	KES75-C025BU	blue
KES75-C025NB	neon-blue	KES75-C025GR	green
KES75-C025NG	neon-green	KES75-C025RE	red
KES75-C025NP	neon-red/pink	KES75-C025VT	violet
KES75-C025NO	neon-orange	KES75-C025BL	black
KES75-C025WH	white	KES75-C025BB	black/black*

*black/black: Lower half and lid black for light-sensitive samples

Matching Racks

Vertical Racks
page 39
Horizontal Racks
page 40–41
Drawer Racks
page 44
Upright Bins
page 47

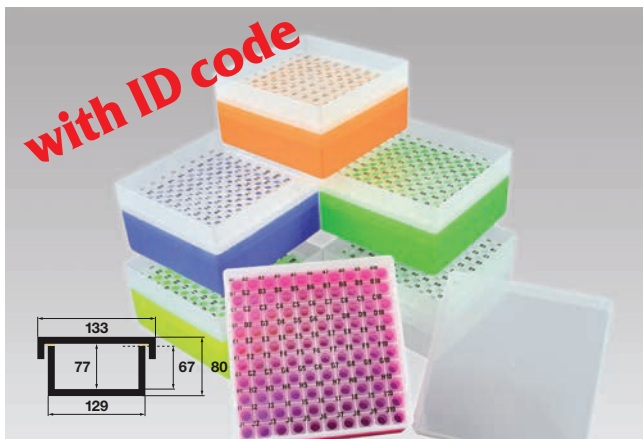

EPPi® 80 / 10x10 • height 80 mm fix

Inner height 77 mm. With two hole inserts 10x10 holes for 100 tubes up to 8.5 mm Ø. With alphanumeric ID code.

Cat. No.	Colour	Cat. No.	Colour
KEB80-C0100NA	natural	KEB80-C0100YE	yellow
KEB80-C0100NY	neon-yellow	KEB80-C0100BU	blue
KEB80-C0100NB	neon-blue	KEB80-C0100GR	green
KEB80-C0100NG	neon-green	KEB80-C0100RE	red
KEB80-C0100NP	neon-red/pink	KEB80-C0100VT	violet
KEB80-C0100NO	neon-orange	KEB80-C0100BL	black
KEB80-C0100WH	white		

Matching Racks

Vertical Racks
page 39
Horizontal Racks
page 40–41
Drawer Racks
page 45
Upright Bins
page 47

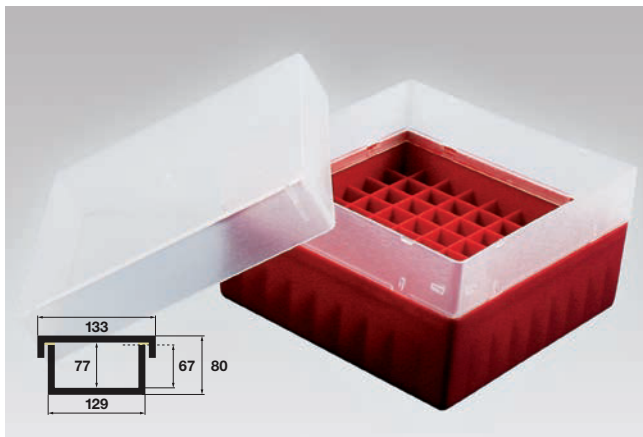

EPPi® 80 / 9x9 • height 80 mm fix

Inner height 77 mm. 9x9 divider holds 81 tubes up to 12.5 mm Ø. Without ID code.

Cat. No.	Colour	Cat. No.	Colour
KEA80-C81NA	natural	KEA80-C81YE	yellow
KEA80-C81NY	neon-yellow	KEA80-C81BU	blue
KEA80-C81NB	neon-blue	KEA80-C81GR	green
KEA80-C81NG	neon-green	KEA80-C81RE	red
KEA80-C81NP	neon-red/pink	KEA80-C81VT	violet
KEA80-C81NO	neon-orange	KEA80-C81BL	black
KEA80-C81WH	white	KEA80-C81BB	black/black*

*black/black: Lower half and lid black for light-sensitive samples

Matching Racks

Vertical Racks
page 39
Horizontal Racks
page 40–41
Drawer Racks
page 45
Upright Bins
page 47

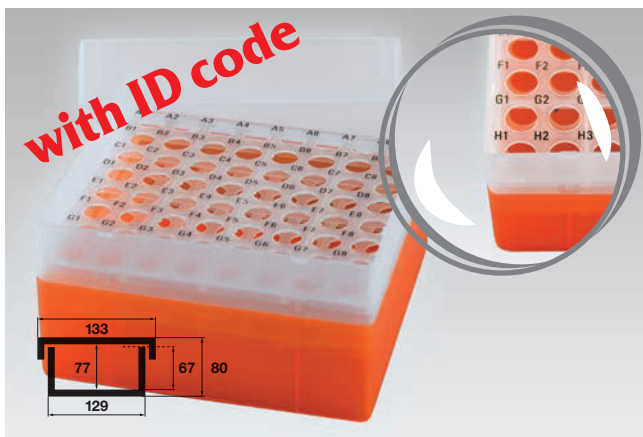

EPPi® 80 / 8x8 • height 80 mm fix

Inner height 77 mm. With two hole inserts 8x8 holes for 64 tubes up to 11 mm Ø. With alphanumeric ID code.

Cat. No.	Colour	Cat. No.	Colour
KEB80-C064NA	natural	KEB80-C064YE	yellow
KEB80-C064NY	neon-yellow	KEB80-C064BU	blue
KEB80-C064NB	neon-blue	KEB80-C064GR	green
KEB80-C064NG	neon-green	KEB80-C064RE	red
KEB80-C064NP	neon-red/pink	KEB80-C064VT	violet
KEB80-C064NO	neon-orange	KEB80-C064BL	black
KEB80-C064WH	white	KEB80-C064BB	black/black*

*black/black: Lower half and lid black for light-sensitive samples

Matching Racks

Vertical Racks
page 39
Horizontal Racks
page 40–41
Drawer Racks
page 45
Upright Bins
page 47

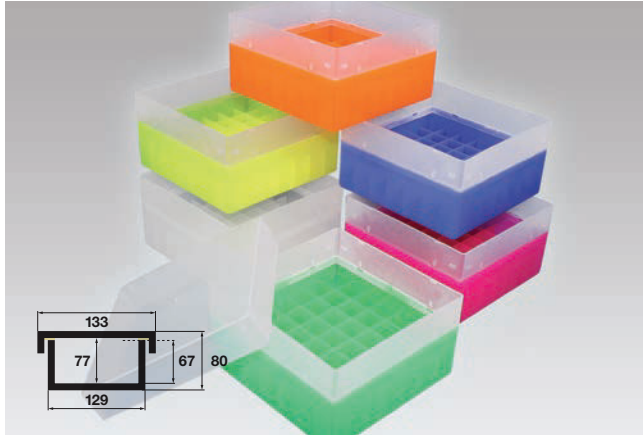

EPPi® 80 / 7x7 • height 80 mm fix

Inner height 77 mm. 7x7 divider holds 49 tubes up to 17 mm Ø. Without ID code.

Cat. No.	Colour	Cat. No.	Colour
KEA80-C49NA	natural	KEA80-C49YE	yellow
KEA80-C49NY	neon-yellow	KEA80-C49BU	blue
KEA80-C49NB	neon-blue	KEA80-C49GR	green
KEA80-C49NG	neon-green	KEA80-C49RE	red
KEA80-C49NP	neon-red/pink	KEA80-C49VT	violet
KEA80-C49NO	neon-orange	KEA80-C49BL	black
KEA80-C49WH	white	KEA80-C49BB	black/black*

*black/black: Lower half and lid black for light-sensitive samples

Matching Racks

Vertical Racks
page 39

Horizontal Racks
page 40–41

Drawer Racks
page 45

Upright Bins
page 47

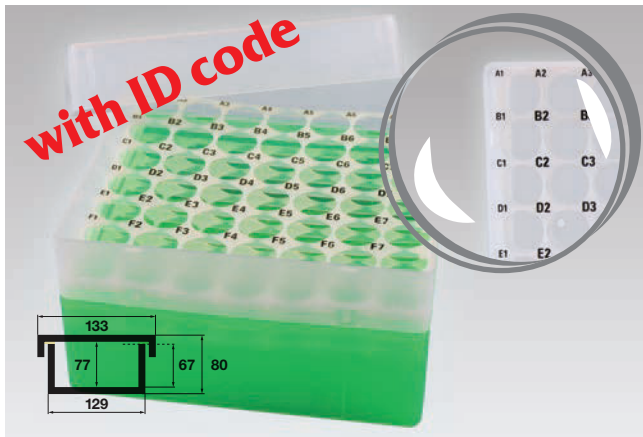

EPPi® 80 / 7x7 • height 80 mm fix

Inner height 77 mm. With two hole inserts 7x7 holes for 49 tubes up to 16.5 mm Ø. With alphanumeric ID code.

Cat. No.	Colour	Cat. No.	Colour
KEB80-C049NA	natural	KEB80-C049YE	yellow
KEB80-C049NY	neon-yellow	KEB80-C049BU	blue
KEB80-C049NB	neon-blue	KEB80-C049GR	green
KEB80-C049NG	neon-green	KEB80-C049RE	red
KEB80-C049NP	neon-red/pink	KEB80-C049VT	violet
KEB80-C049NO	neon-orange	KEB80-C049BL	black
KEB80-C049WH	white	KEB80-C049BB	black/black*

*black/black: Lower half and lid black for light-sensitive samples

Matching Racks

Vertical Racks
page 39

Horizontal Racks
page 40–41

Drawer Racks
page 45

Upright Bins
page 47



EPPi® 80 / 5x5 • height 80 mm fix

Inner height 77 mm. With two hole inserts 5x5 holes for 25 reaction vessels and tubes up to 16.6 mm Ø. With numeric ID code. Alphanumeric ID code on request. (See also page 19: KES67..).

Cat. No.	Colour	Cat. No.	Colour
KES80-C025NA	natural	KES80-C025YE	yellow
KES80-C025NY	neon-yellow	KES80-C025BU	blue
KES80-C025NB	neon-blue	KES80-C025GR	green
KES80-C025NG	neon-green	KES80-C025RE	red
KES80-C025NP	neon-red/pink	KES80-C025VT	violet
KES80-C025NO	neon-orange	KES80-C025BL	black
KES80-C025WH	white	KES80-C025BB	black/black*

*black/black: Lower half and lid black for light-sensitive samples

Matching Racks

Vertical Racks
page 39

Horizontal Racks
page 40–41

Drawer Racks
page 45

Upright Bins
page 47



EPPi® 80 / 3x3 • height 80 mm fix

Inner height 77 mm. With two hole inserts 3x3 holes for 9 tubes up to 30 mm Ø. With numeric ID code. Alphanumeric ID code on request.

Cat. No.	Colour	Cat. No.	Colour
KES80-C09NA	natural	KES80-C09YE	yellow
KES80-C09NY	neon-yellow	KES80-C09BU	blue
KES80-C09NB	neon-blue	KES80-C09GR	green
KES80-C09NG	neon-green	KES80-C09RE	red
KES80-C09NP	neon-red/pink	KES80-C09VT	violet
KES80-C09NO	neon-orange	KES80-C09BL	black
KES80-C09WH	white	KES80-C09BB	black/black*

*black/black: Lower half and lid black for light-sensitive samples

Matching Racks

Vertical Racks
page 39

Horizontal Racks
page 40–41

Drawer Racks
page 45

Upright Bins
page 47

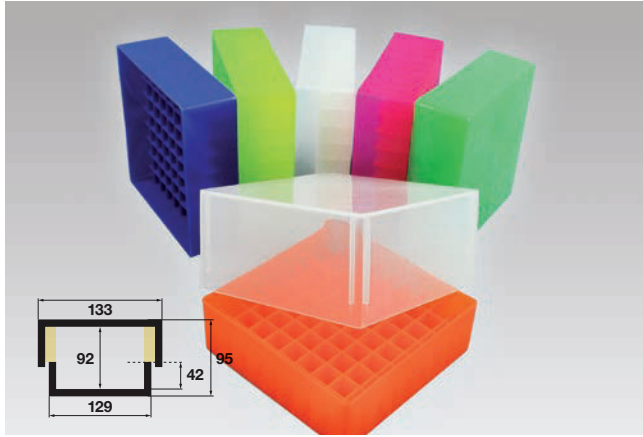

EPPi® 95 / 9x9 • height 95 mm fix

Inner height 92 mm. 9x9 divider holds 81 tubes up to 12.5 mm Ø. Such as for 5 ml cryo tubes. Without ID code.

Cat. No.	Colour	Cat. No.	Colour
KEA95-C81NA	natural	KEA95-C81YE	yellow
KEA95-C81NY	neon-yellow	KEA95-C81BU	blue
KEA95-C81NB	neon-blue	KEA95-C81GR	green
KEA95-C81NG	neon-green	KEA95-C81RE	red
KEA95-C81NP	neon-red/pink	KEA95-C81VT	violet
KEA95-C81NO	neon-orange	KEA95-C81BL	black
KEA95-C81WH	white	KEA95-C81BB	black/black*

*black/black: Lower half and lid black for light-sensitive samples

Matching Racks

- Vertical Racks page 39
- Horizontal Racks page 40–41
- Drawer Racks page 45
- Upright Bins page 47

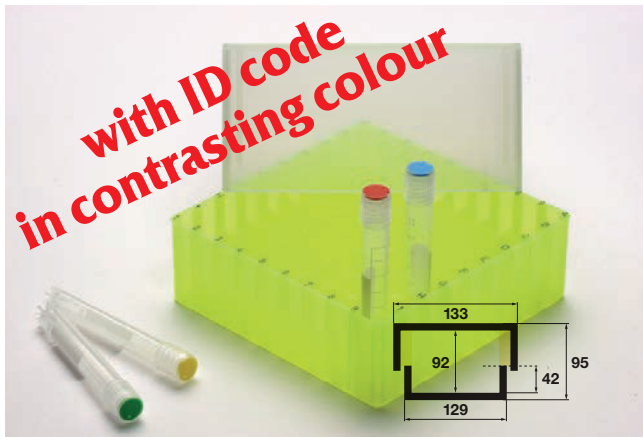

EPPi® 95 / 9x9 • height 95 mm fix

Inner height 92 mm. 9x9 divider holds 81 tubes up to 12.5 mm Ø. With alphanumeric ID code on all 4 sides. Such as for 5 ml cryo tubes.

Cat. No.	Colour	Cat. No.	Colour
KEB95-C81NA	natural	KEB95-C81YE	yellow
KEB95-C81NY	neon-yellow	KEB95-C81BU	blue
KEB95-C81NB	neon-blue	KEB95-C81GR	green
KEB95-C81NG	neon-green	KEB95-C81RE	red
KEB95-C81NP	neon-red/pink	KEB95-C81VT	violet
KEB95-C81NO	neon-orange	KEB95-C81BL	black
KEB95-C81WH	white	KEB95-C81BB	black/black*

*black/black: Lower half and lid black for light-sensitive samples

Matching Racks

- Vertical Racks page 39
- Horizontal Racks page 40–41
- Drawer Racks page 45
- Upright Bins page 47

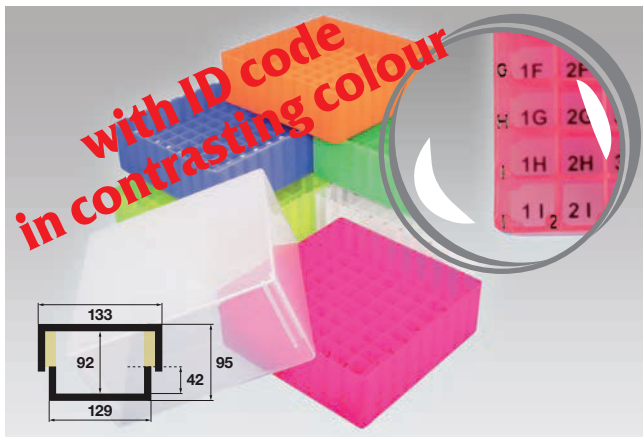

EPPi® 95 / 9x9 • height 95 mm fix

Inner height 92 mm. 9x9 divider holds 81 tubes up to 12.5 mm Ø. With alphanumeric ID code on all 4 sides as well as on the bottom (transparent). Such as for 5 ml cryo tubes.

Cat. No.	Colour
KEC95-C81NA	natural
KEC95-C81NY	neon-yellow
KEC95-C81NB	neon-blue
KEC95-C81NG	neon-green
KEC95-C81NP	neon-red/pink
KEC95-C81NO	neon-orange

Matching Racks

- Vertical Racks page 39
- Horizontal Racks page 40–41
- Drawer Racks page 45
- Upright Bins page 47



EPPi® 95 / 9x9 • height 95 mm fix

Inner height 92 mm. 9x9 divider holds 81 tubes up to 12.5 mm Ø. With alphanumeric ID code on all 4 sides as well as on the bottom of the box (transparent) and on the lid. Such as for 5 ml cryo tubes.

Cat. No.	Colour
KEE95-C81NA	natural
KEE95-C81NY	neon-yellow
KEE95-C81NB	neon-blue
KEE95-C81NG	neon-green
KEE95-C81NP	neon-red/pink
KEE95-C81NO	neon-orange

Matching Racks

- Vertical Racks page 39
- Horizontal Racks page 40–41
- Drawer Racks page 45
- Upright Bins page 47

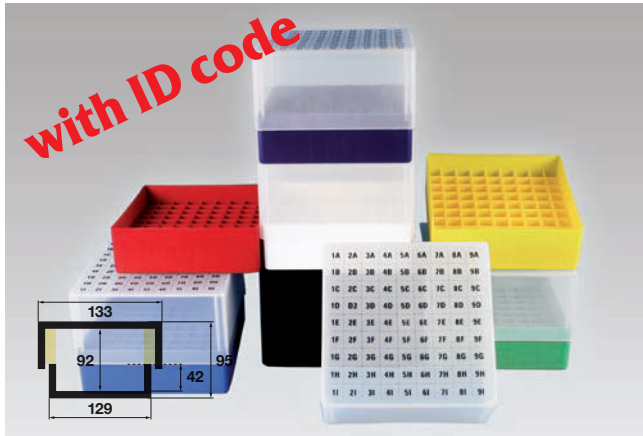

EPPi® 95 / 9x9 • height 95 mm fix

Inner height 92 mm. 9x9 divider holds 81 tubes up to 12.5 mm Ø. With alphanumeric ID code on the lid. Such as for 5 ml cryo tubes.

Cat. No.	Colour
KEH95-C81NA	natural
KEH95-C81NY	neon-yellow
KEH95-C81NB	neon-blue
KEH95-C81NG	neon-green
KEH95-C81NP	neon-red/pink
KEH95-C81NO	neon-orange
KEH95-C81RE	red

Matching Racks

Vertical Racks
page 39
Horizontal Racks
page 40–41
Drawer Racks
page 45
Upright Bins
page 47



EPPi® 95 / 9x9 • height 95 mm fix

Inner height 92 mm. 9x9 divider holds 81 tubes up to 12.5 mm Ø. With alphanumeric ID code on all 4 sides and on the lid. Such as for 5 ml cryo tubes.

Cat. No.	Colour
KEK95-C81NA	natural
KEK95-C81NY	neon-yellow
KEK95-C81NB	neon-blue
KEK95-C81NG	neon-green
KEK95-C81NP	neon-red/pink
KEK95-C81NO	neon-orange
KEK95-C81RE	red

Matching Racks

Vertical Racks
page 39
Horizontal Racks
page 40–41
Drawer Racks
page 45
Upright Bins
page 47



EPPi® 95 / 9x9 • height 95 mm fix

Inner height 92 mm. 9x9 divider holds 81 tubes up to 12.5 mm Ø. With numeric ID code (1–81) on the lid. Such as for 5 ml cryo tubes.

Cat. No.	Colour
KEM95-C81NA	natural
KEM95-C81NY	neon-yellow
KEM95-C81NB	neon-blue
KEM95-C81NG	neon-green
KEM95-C81NP	neon-red/pink
KEM95-C81NO	neon-orange
KEM95-C81RE	red

Matching Racks

Vertical Racks
page 39
Horizontal Racks
page 40–41
Drawer Racks
page 45
Upright Bins
page 47

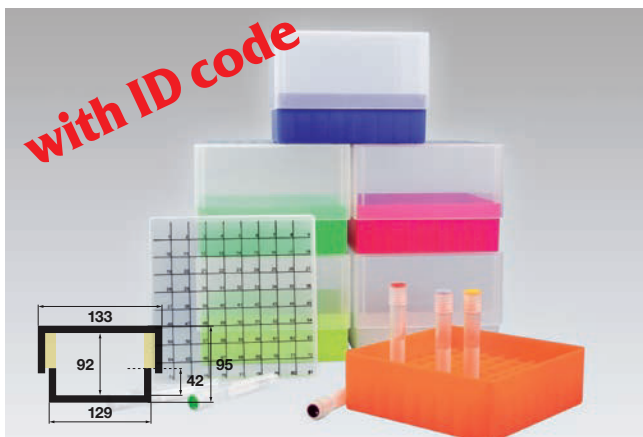

EPPi® 95 / 9x9 • height 95 mm fix

Inner height 92 mm. 9x9 divider holds 81 tubes up to 12.5 mm Ø. With numeric ID code (1–81) on the bottom of the box (transparent) and on the lid. Such as for 5 ml cryo tubes.

Cat. No.	Colour
KER95-C81NA	natural
KER95-C81NY	neon-yellow
KER95-C81NB	neon-blue
KER95-C81NG	neon-green
KER95-C81NP	neon-red/pink
KER95-C81NO	neon-orange

Matching Racks

Vertical Racks
page 39
Horizontal Racks
page 40–41
Drawer Racks
page 45
Upright Bins
page 47

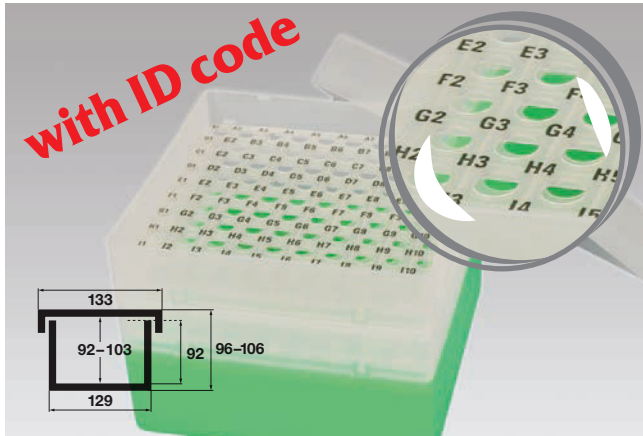

EPPi® 96 / 10x10 • height 96–106 mm variable

With two hole inserts 10x10 holes for 100 tubes up to 8.5 mm Ø. With alphanumeric ID code.

Cat. No.	Colour	Cat. No.	Colour
KEB96-V0100NA	natural	KEB96-V0100YE	yellow
KEB96-V0100NY	neon-yellow	KEB96-V0100BU	blue
KEB96-V0100NB	neon-blue	KEB96-V0100GR	green
KEB96-V0100NG	neon-green	KEB96-V0100RE	red
KEB96-V0100NP	neon-red/pink	KEB96-V0100VT	violet
KEB96-V0100NO	neon-orange	KEB96-V0100BL	black
KEB96-V0100WH	white	KEB96-V0100BB	black/black*

*black/black: Lower half and lid black for light-sensitive samples

Matching Racks

Vertical Racks
page 39
Horizontal Racks
page 40–41
Drawer Racks
page 45
Upright Bins
page 47

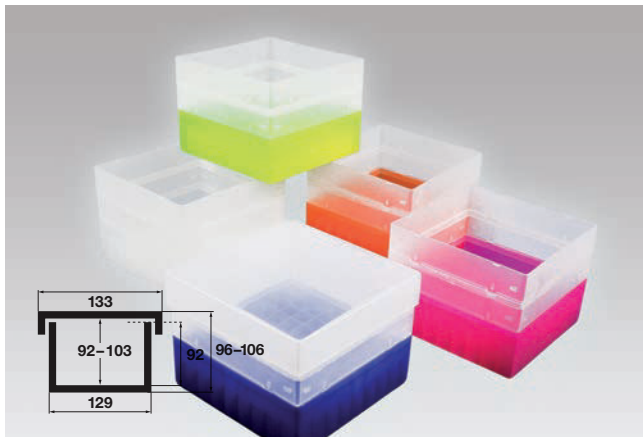

EPPi® 96 / 9x9 • height 96–106 mm variable

9x9 divider holds 81 tubes up to 12.5 mm Ø. Without ID code. (See also page 26: KEA95..).

Cat. No.	Colour	Cat. No.	Colour
KEA96-V81NA	natural	KEA96-V81YE	yellow
KEA96-V81NY	neon-yellow	KEA96-V81BU	blue
KEA96-V81NB	neon-blue	KEA96-V81GR	green
KEA96-V81NG	neon-green	KEA96-V81RE	red
KEA96-V81NP	neon-red/pink	KEA96-V81VT	violet
KEA96-V81NO	neon-orange	KEA96-V81BL	black
KEA96-V81WH	white	KEA96-V81BB	black/black*

*black/black: Lower half and lid black for light-sensitive samples

Matching Racks

Vertical Racks
page 39
Horizontal Racks
page 40–41
Drawer Racks
page 45
Upright Bins
page 47



EPPi® 96 / 8x8 • height 96–106 mm variable

With two hole inserts 8x8 holes for 64 tubes up to 11 mm Ø. With alphanumeric ID code. (See also page 26: KEB95..).

Cat. No.	Colour	Cat. No.	Colour
KEB96-V064NA	natural	KEB96-V064YE	yellow
KEB96-V064NY	neon-yellow	KEB96-V064BU	blue
KEB96-V064NB	neon-blue	KEB96-V064GR	green
KEB96-V064NG	neon-green	KEB96-V064RE	red
KEB96-V064NP	neon-red/pink	KEB96-V064VT	violet
KEB96-V064NO	neon-orange	KEB96-V064BL	black
KEB96-V064WH	white	KEB96-V064BB	black/black*

*black/black: Lower half and lid black for light-sensitive samples

Matching Racks

Vertical Racks
page 39
Horizontal Racks
page 40–41
Drawer Racks
page 45
Upright Bins
page 47

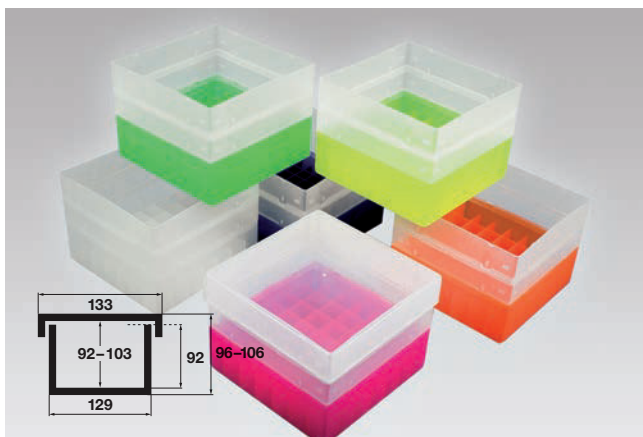

EPPi® 96 / 7x7 • height 96–106 mm variable

7x7 divider holds 49 tubes up to 17 mm Ø. Without ID code. (See also page 26: KEA95..).

Cat. No.	Colour	Cat. No.	Colour
KEA96-V49NA	natural	KEA96-V49YE	yellow
KEA96-V49NY	neon-yellow	KEA96-V49BU	blue
KEA96-V49NB	neon-blue	KEA96-V49GR	green
KEA96-V49NG	neon-green	KEA96-V49RE	red
KEA96-V49NP	neon-red/pink	KEA96-V49VT	violet
KEA96-V49NO	neon-orange	KEA96-V49BL	black
KEA96-V49WH	white	KEA96-V49BB	black/black*

*black/black: Lower half and lid black for light-sensitive samples

Matching Racks

Vertical Racks
page 39
Horizontal Racks
page 40–41
Drawer Racks
page 45
Upright Bins
page 47

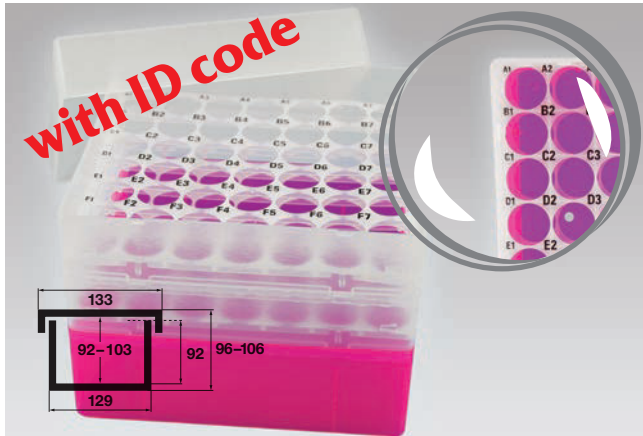

EPPi® 96 / 7x7 • height 96–106 mm variable

With two hole inserts 7x7 holes for 49 tubes up to 16.5 mm Ø. With alphanumeric ID code.

Cat. No.	Colour	Cat. No.	Colour
KEB96-V049NA	natural	KEB96-V049YE	yellow
KEB96-V049NY	neon-yellow	KEB96-V049BU	blue
KEB96-V049NB	neon-blue	KEB96-V049GR	green
KEB96-V049NG	neon-green	KEB96-V049RE	red
KEB96-V049NP	neon-red/pink	KEB96-V049VT	violet
KEB96-V049NO	neon-orange	KEB96-V049BL	black
KEB96-V049WH	white	KEB96-V049BB	black/black*

*black/black: Lower half and lid black for light-sensitive samples

Matching Racks

Vertical Racks
page 39
Horizontal Racks
page 40–41
Drawer Racks
page 45
Upright Bins
page 47

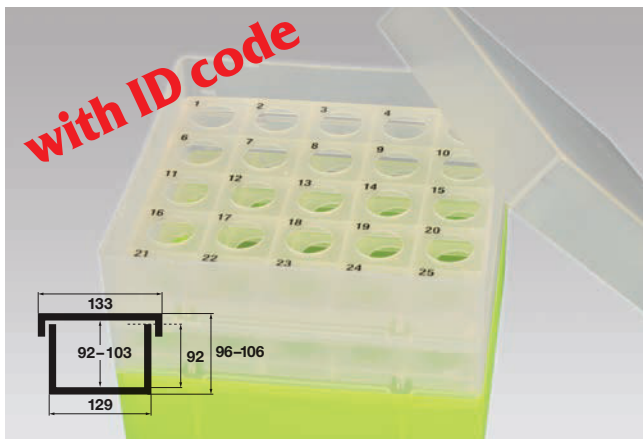

EPPi® 96 / 5x5 • height 96–106 mm variable

With two hole inserts 5x5 holes for 25 reaction vessels and tubes up to 16.6 mm Ø. With numeric ID code. Alphanumeric ID code on request. (See also page 19: KES67..).

Cat. No.	Colour	Cat. No.	Colour
KES96-V025NA	natural	KES96-V025YE	yellow
KES96-V025NY	neon-yellow	KES96-V025BU	blue
KES96-V025NB	neon-blue	KES96-V025GR	green
KES96-V025NG	neon-green	KES96-V025RE	red
KES96-V025NP	neon-red/pink	KES96-V025VT	violet
KES96-V025NO	neon-orange	KES96-V025BL	black
KES96-V025WH	white	KES96-V025BB	black/black*

*black/black: Lower half and lid black for light-sensitive samples

Matching Racks

Vertical Racks
page 39
Horizontal Racks
page 40–41
Drawer Racks
page 45
Upright Bins
page 47

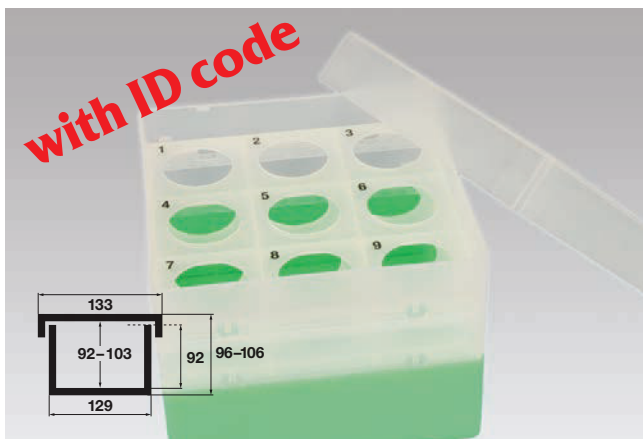

EPPi® 96 / 3x3 • height 96–106 mm variable

With two hole inserts 3x3 holes for 9 tubes up to 30 mm Ø. With numeric ID code. Alphanumeric ID code on request.

Cat. No.	Colour	Cat. No.	Colour
KES96-V09NA	natural	KES96-V09YE	yellow
KES96-V09NY	neon-yellow	KES96-V09BU	blue
KES96-V09NB	neon-blue	KES96-V09GR	green
KES96-V09NG	neon-green	KES96-V09RE	red
KES96-V09NP	neon-red/pink	KES96-V09VT	violet
KES96-V09NO	neon-orange	KES96-V09BL	black
KES96-V09WH	white	KES96-V09BB	black/black*

*black/black: Lower half and lid black for light-sensitive samples

Matching Racks

Vertical Racks
page 39
Horizontal Racks
page 40–41
Drawer Racks
page 45
Upright Bins
page 47

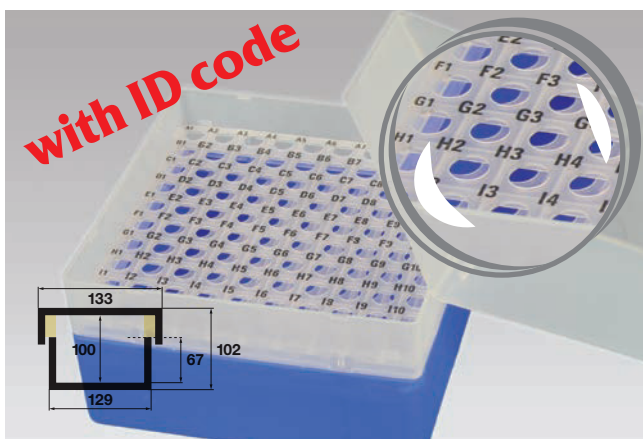

EPPi® 102 / 10x10 • height 102 mm fix

Inner height 100 mm. With two hole inserts 10x10 holes for 100 tubes up to 8.5 mm Ø. With alphanumeric ID code.

Cat. No.	Colour	Cat. No.	Colour
KEB102-C0100NA	natural	KEB102-C0100YE	yellow
KEB102-C0100NY	neon-yellow	KEB102-C0100BU	blue
KEB102-C0100NB	neon-blue	KEB102-C0100GR	green
KEB102-C0100NG	neon-green	KEB102-C0100RE	red
KEB102-C0100NP	neon-red/pink	KEB102-C0100VT	violet
KEB102-C0100NO	neon-orange	KEB102-C0100BL	black
KEB102-C0100WH	white	KEB102-C0100BB	black/black*

*black/black: Lower half and lid black for light-sensitive samples

Matching Racks

Vertical Racks
page 39
Horizontal Racks
page 40–41
Drawer Racks
page 45
Upright Bins
page 47

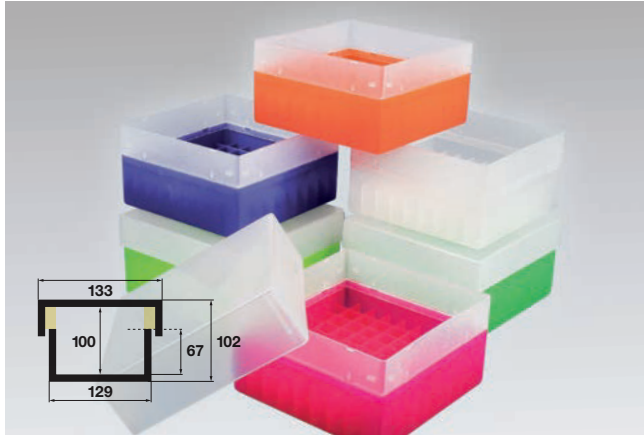

EPPi® 102 / 9x9 • height 102 mm fix

Inner height 100 mm. 9x9 divider holds 81 tubes up to 12.5 mm Ø. Without ID code.

Cat. No.	Colour	Cat. No.	Colour
KEA102-C81NA	natural	KEA102-C81YE	yellow
KEA102-C81NY	neon-yellow	KEA102-C81BU	blue
KEA102-C81NB	neon-blue	KEA102-C81GR	green
KEA102-C81NG	neon-green	KEA102-C81RE	red
KEA102-C81NP	neon-red/pink	KEA102-C81VT	violet
KEA102-C81NO	neon-orange	KEA102-C81BL	black
KEA102-C81WH	white	KEA102-C81BB	black/black*

*black/black: Lower half and lid black for light-sensitive samples

Matching Racks

Vertical Racks
page 39

Horizontal Racks
page 40–41

Drawer Racks
page 45

Upright Bins
page 47



EPPi® 102 / 8x8 • height 102 mm fix

Inner height 100 mm. With two hole inserts 8x8 holes for 64 tubes up to 11 mm Ø. With alphanumeric ID code.

Cat. No.	Colour	Cat. No.	Colour
KEB102-C064NA	natural	KEB102-C064YE	yellow
KEB102-C064NY	neon-yellow	KEB102-C064BU	blue
KEB102-C064NB	neon-blue	KEB102-C064GR	green
KEB102-C064NG	neon-green	KEB102-C064RE	red
KEB102-C064NP	neon-red/pink	KEB102-C064VT	violet
KEB102-C064NO	neon-orange	KEB102-C064BL	black
KEB102-C064WH	white	KEB102-C064BB	black/black*

*black/black: Lower half and lid black for light-sensitive samples

Matching Racks

Vertical Racks
page 39

Horizontal Racks
page 40–41

Drawer Racks
page 45

Upright Bins
page 47

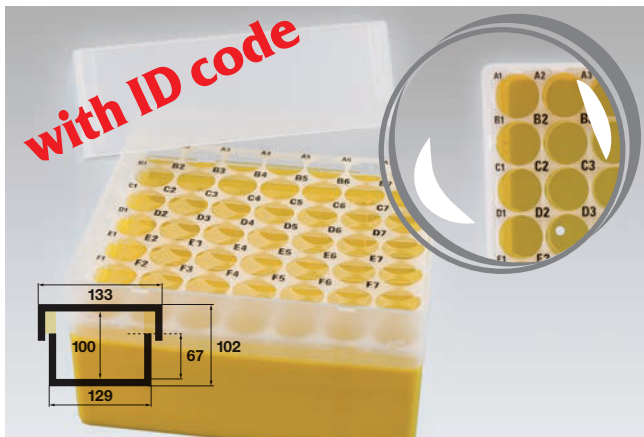

EPPi® 102 / 7x7 • height 102 mm fix

Inner height 100 mm. With two hole inserts 7x7 holes for 49 tubes up to 16.5 mm Ø. With alphanumeric ID code.

Cat. No.	Colour	Cat. No.	Colour
KEB102-C049NA	natural	KEB102-C049YE	yellow
KEB102-C049NY	neon-yellow	KEB102-C049BU	blue
KEB102-C049NB	neon-blue	KEB102-C049GR	green
KEB102-C049NG	neon-green	KEB102-C049RE	red
KEB102-C049NP	neon-red/pink	KEB102-C049VT	violet
KEB102-C049NO	neon-orange	KEB102-C049BL	black
KEB102-C049WH	white	KEB102-C049BB	black/black*

*black/black: Lower half and lid black for light-sensitive samples

Matching Racks

Vertical Racks
page 39

Horizontal Racks
page 40–41

Drawer Racks
page 45

Upright Bins
page 47

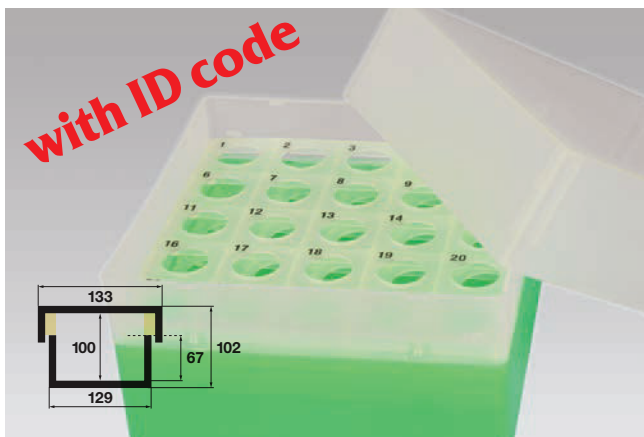

EPPi® 102 / 5x5 • height 102 mm fix

Inner height 100 mm. With two hole inserts 5x5 holes for 25 tubes up to 16.6 mm Ø. With numeric ID code. Alphanumeric ID code on request.

Cat. No.	Colour	Cat. No.	Colour
KES102-C025NA	natural	KES102-C025YE	yellow
KES102-C025NY	neon-yellow	KES102-C025BU	blue
KES102-C025NB	neon-blue	KES102-C025GR	green
KES102-C025NG	neon-green	KES102-C025RE	red
KES102-C025NP	neon-red/pink	KES102-C025VT	violet
KES102-C025NO	neon-orange	KES102-C025BL	black
KES102-C025WH	white	KES102-C025BB	black/black*

*black/black: Lower half and lid black for light-sensitive samples

Matching Racks

Vertical Racks
page 39

Horizontal Racks
page 40–41

Drawer Racks
page 45

Upright Bins
page 47

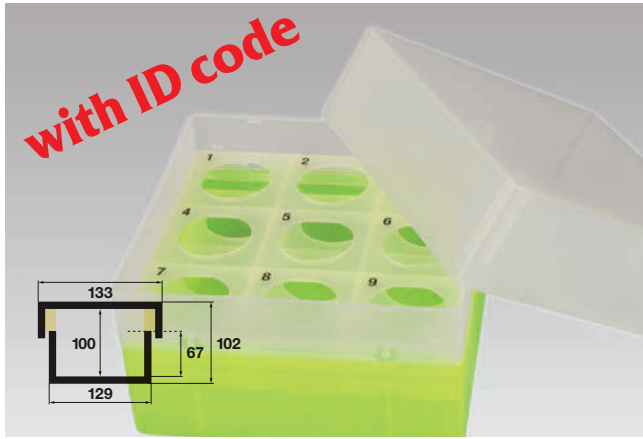

EPPi® 102 / 3x3 • height 102 mm fix

Inner height 100 mm. With two hole inserts
3x3 holes for 9 tubes up to 30 mm Ø.
With numeric ID code. Alphanumeric
ID code on request.

Cat. No.	Colour	Cat. No.	Colour
KES102-C09NA	natural	KES102-C09YE	yellow
KES102-C09NY	neon-yellow	KES102-C09BU	blue
KES102-C09NB	neon-blue	KES102-C09GR	green
KES102-C09NG	neon-green	KES102-C09RE	red
KES102-C09NP	neon-red/pink	KES102-C09VT	violet
KES102-C09NO	neon-orange	KES102-C09BL	black
KES102-C09WH	white	KES102-C09BB	black/black*

*black/black: Lower half and lid black for light-sensitive samples

Matching Racks

Vertical Racks
page 39

Horizontal Racks
page 40–41

Drawer Racks
page 45

Upright Bins
page 47

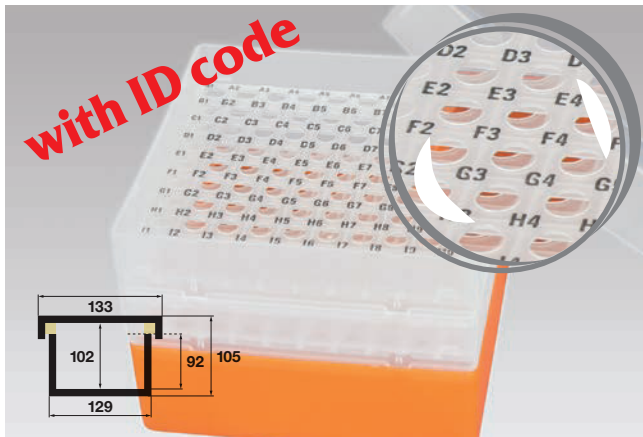

EPPi® 105 / 10x10 • height 105 mm fix

Inner height 102 mm. With two hole inserts
10x10 holes for 100 tubes up to 8.5 mm Ø.
With alphanumeric ID code.

Cat. No.	Colour	Cat. No.	Colour
KEB105-C0100NA	natural	KEB105-C0100YE	yellow
KEB105-C0100NY	neon-yellow	KEB105-C0100BU	blue
KEB105-C0100NB	neon-blue	KEB105-C0100GR	green
KEB105-C0100NG	neon-green	KEB105-C0100RE	red
KEB105-C0100NP	neon-red/pink	KEB105-C0100VT	violet
KEB105-C0100NO	neon-orange	KEB105-C0100BL	black
KEB105-C0100WH	white	KEB105-C0100BB	black/black*

*black/black: Lower half and lid black for light-sensitive samples

Matching Racks

Vertical Racks
page 39

Horizontal Racks
page 40–41

Drawer Racks
page 46

Upright Bins
page 47

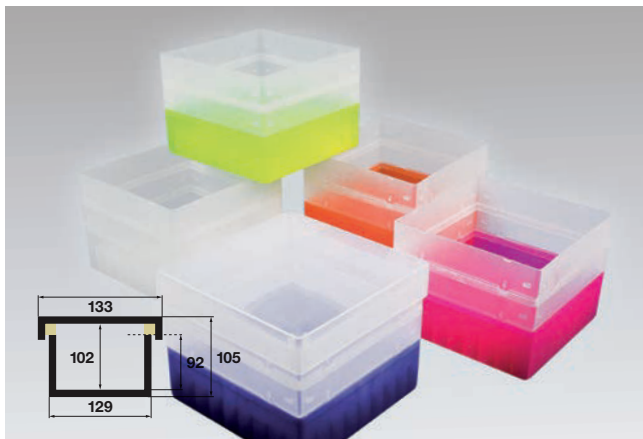

EPPi® 105 / 9x9 • height 105 mm fix

Inner height 102 mm. 9x9 divider holds 81 tubes up
to 12.5 mm Ø. Without ID code.

Cat. No.	Colour	Cat. No.	Colour
KEA105-C81NA	natural	KEA105-C81YE	yellow
KEA105-C81NY	neon-yellow	KEA105-C81BU	blue
KEA105-C81NB	neon-blue	KEA105-C81GR	green
KEA105-C81NG	neon-green	KEA105-C81RE	red
KEA105-C81NP	neon-red/pink	KEA105-C81VT	violet
KEA105-C81NO	neon-orange	KEA105-C81BL	black
KEA105-C81WH	white	KEA105-C81BB	black/black*

*black/black: Lower half and lid black for light-sensitive samples

Matching Racks

Vertical Racks
page 39

Horizontal Racks
page 40–41

Drawer Racks
page 46

Upright Bins
page 47

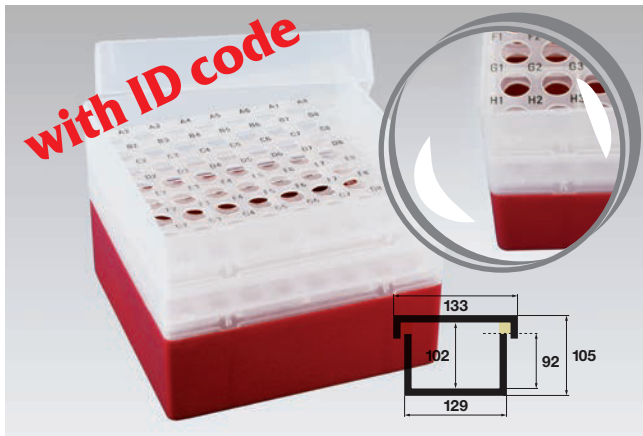

EPPi® 105 / 8x8 • height 105 mm fix

Inner height 102 mm. With two hole inserts
8x8 holes for 64 tubes up to 11 mm Ø.
With alphanumeric ID code.

Cat. No.	Colour	Cat. No.	Colour
KEB105-C064NA	natural	KEB105-C064YE	yellow
KEB105-C064NY	neon-yellow	KEB105-C064BU	blue
KEB105-C064NB	neon-blue	KEB105-C064GR	green
KEB105-C064NG	neon-green	KEB105-C064RE	red
KEB105-C064NP	neon-red/pink	KEB105-C064VT	violet
KEB105-C064NO	neon-orange	KEB105-C064BL	black
KEB105-C064WH	white	KEB105-C064BB	black/black*

*black/black: Lower half and lid black for light-sensitive samples

Matching Racks

Vertical Racks
page 39

Horizontal Racks
page 40–41

Drawer Racks
page 46

Upright Bins
page 47

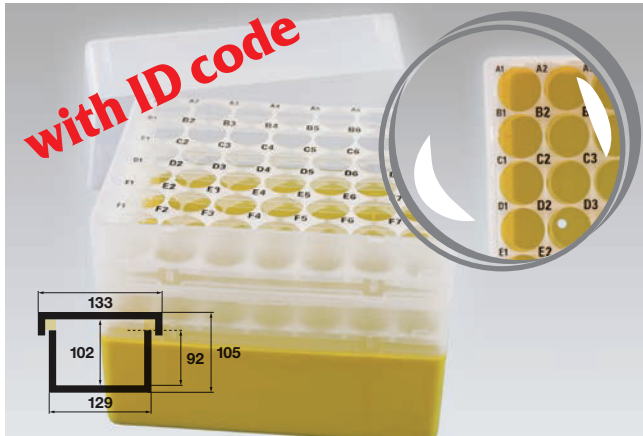

EPPi® 105 / 7x7 • height 105 mm fix

Inner height 102 mm. With two hole inserts
7x7 holes for 49 tubes up to 16.5 mm Ø.
With alphanumeric ID code.

Cat. No.	Colour	Cat. No.	Colour
KEB105-C049NA	natural	KEB105-C049YE	yellow
KEB105-C049NY	neon-yellow	KEB105-C049BU	blue
KEB105-C049NB	neon-blue	KEB105-C049GR	green
KEB105-C049NG	neon-green	KEB105-C049RE	red
KEB105-C049NP	neon-red/pink	KEB105-C049VT	violet
KEB105-C049NO	neon-orange	KEB105-C049BL	black
KEB105-C049WH	white	KEB105-C049BB	black/black*

*black/black: Lower half and lid black for light-sensitive samples

Matching Racks

Vertical Racks
page 39
Horizontal Racks
page 40–41
Drawer Racks
page 46
Upright Bins
page 47

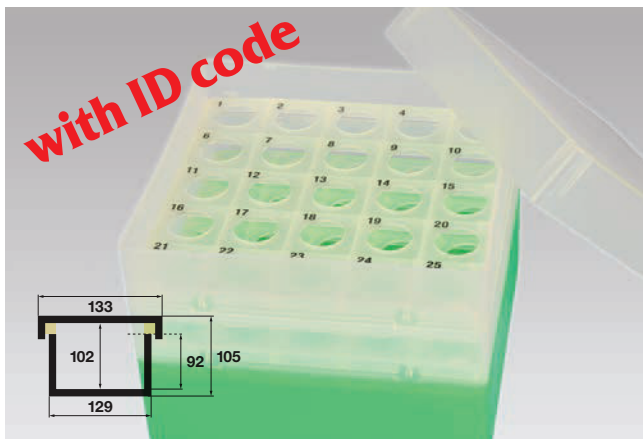

EPPi® 105 / 5x5 • height 105 mm fix

Inner height 102 mm. With two hole inserts
5x5 holes for 25 tubes up to 16.6 mm Ø.
With numeric ID code. Alphanumeric ID code
on request.

Cat. No.	Colour	Cat. No.	Colour
KES105-C025NA	natural	KES105-C025YE	yellow
KES105-C025NY	neon-yellow	KES105-C025BU	blue
KES105-C025NB	neon-blue	KES105-C025GR	green
KES105-C025NG	neon-green	KES105-C025RE	red
KES105-C025NP	neon-red/pink	KES105-C025VT	violet
KES105-C025NO	neon-orange	KES105-C025BL	black
KES105-C025WH	white	KES105-C025BB	black/black*

*black/black: Lower half and lid black for light-sensitive samples

Matching Racks

Vertical Racks
page 39
Horizontal Racks
page 40–41
Drawer Racks
page 46
Upright Bins
page 47

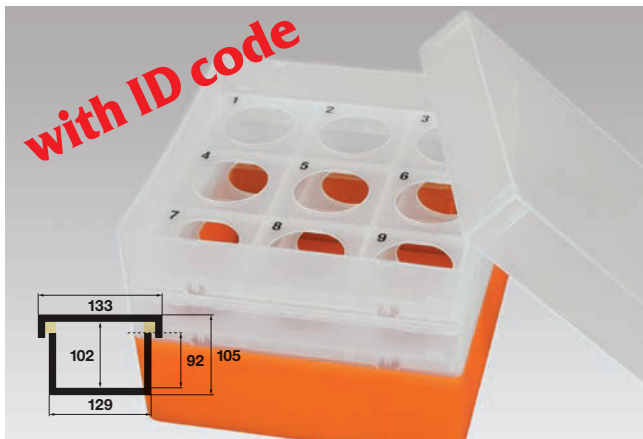

EPPi® 105 / 3x3 • height 105 mm fix

Inner height 102 mm. With two hole inserts
3x3 holes for 9 tubes up to 30 mm Ø.
With numeric ID code. Alphanumeric ID code
on request.

Cat. No.	Colour	Cat. No.	Colour
KES105-C09NA	natural	KES105-C09YE	yellow
KES105-C09NY	neon-yellow	KES105-C09BU	blue
KES105-C09NB	neon-blue	KES105-C09GR	green
KES105-C09NG	neon-green	KES105-C09RE	red
KES105-C09NP	neon-red/pink	KES105-C09VT	violet
KES105-C09NO	neon-orange	KES105-C09BL	black
KES105-C09WH	white	KES105-C09BB	black/black*

*black/black: Lower half and lid black for light-sensitive samples

Matching Racks

Vertical Racks
page 39
Horizontal Racks
page 40–41
Drawer Racks
page 46
Upright Bins
page 47

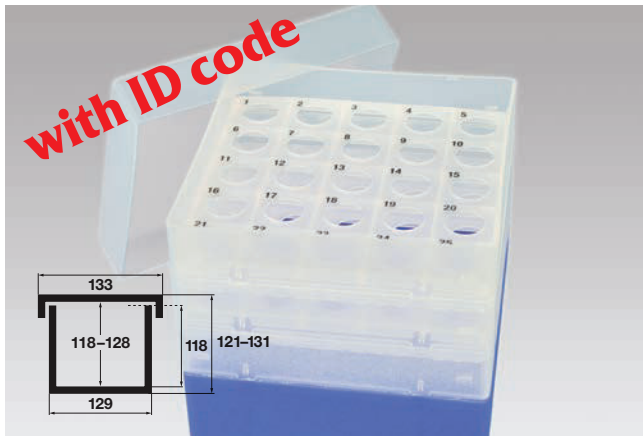

EPPi® 121 / 5x5 • height 121-131 mm variable

With two hole inserts 5x5 holes for 25 reaction
vessels and tubes up to 16.6 mm Ø. With numeric
ID code. Alphanumeric ID code on request.
(See also page 19: KES67..).

Cat. No.	Colour	Cat. No.	Colour
KES121-V025NA	natural	KES121-V025YE	yellow
KES121-V025NY	neon-yellow	KES121-V025BU	blue
KES121-V025NB	neon-blue	KES121-V025GR	green
KES121-V025NG	neon-green	KES121-V025RE	red
KES121-V025NP	neon-red/pink	KES121-V025VT	violet
KES121-V025NO	neon-orange	KES121-V025BL	black
KES121-V025WH	white	KES121-V025BB	black/black*

*black/black: Lower half and lid black for light-sensitive samples

Matching Racks

Vertical Racks
page 39
Horizontal Racks
page 40–41
Drawer Racks
page 46
Upright Bins
page 47

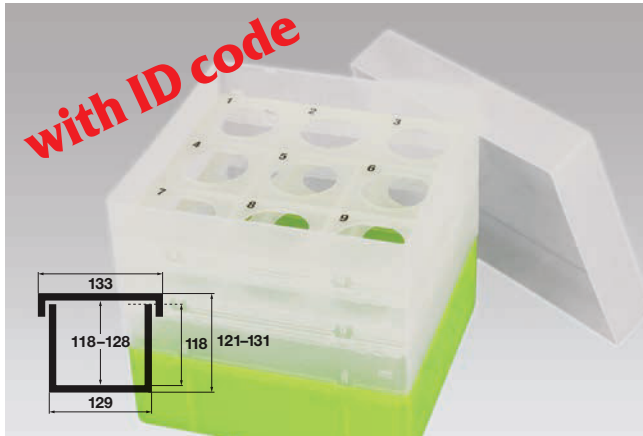

EPPi® 121 / 3x3 • height 121-131 mm variable

With two hole inserts 3x3 holes for 9 tubes up to 30 mm Ø. With numeric ID code. Alphanumeric ID code on request.

Cat. No.	Colour	Cat. No.	Colour
KES121-V09NA	natural	KES121-V09YE	yellow
KES121-V09NY	neon-yellow	KES121-V09BU	blue
KES121-V09NB	neon-blue	KES121-V09GR	green
KES121-V09NG	neon-green	KES121-V09RE	red
KES121-V09NP	neon-red/pink	KES121-V09VT	violet
KES121-V09NO	neon-orange	KES121-V09BL	black
KES121-V09WH	white	KES121-V09BB	black/black*

*black/black: Lower half and lid black for light-sensitive samples

Matching Racks

Vertical Racks
page 39

Horizontal Racks
page 40-41

Drawer Racks
page 46

Upright Bins
page 47

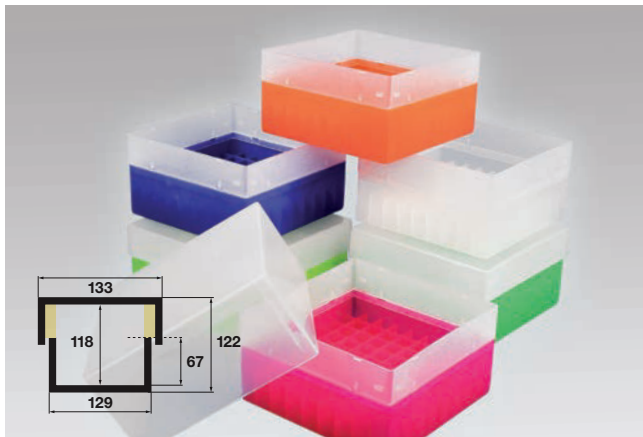

EPPi® 122 / 9x9 • height 122 mm fix

Inner height 118 mm. 9x9 divider holds 81 tubes up to 12.5 mm Ø. Without ID code.

Cat. No.	Colour	Cat. No.	Colour
KEA122-C81NA	natural	KEA122-C81YE	yellow
KEA122-C81NY	neon-yellow	KEA122-C81BU	blue
KEA122-C81NB	neon-blue	KEA122-C81GR	green
KEA122-C81NG	neon-green	KEA122-C81RE	red
KEA122-C81NP	neon-red/pink	KEA122-C81VT	violet
KEA122-C81NO	neon-orange	KEA122-C81BL	black
KEA122-C81WH	white	KEA122-C81BB	black/black*

*black/black: Lower half and lid black for light-sensitive samples

Matching Racks

Vertical Racks
page 39

Horizontal Racks
page 40-41

Drawer Racks
page 46

Upright Bins
page 47

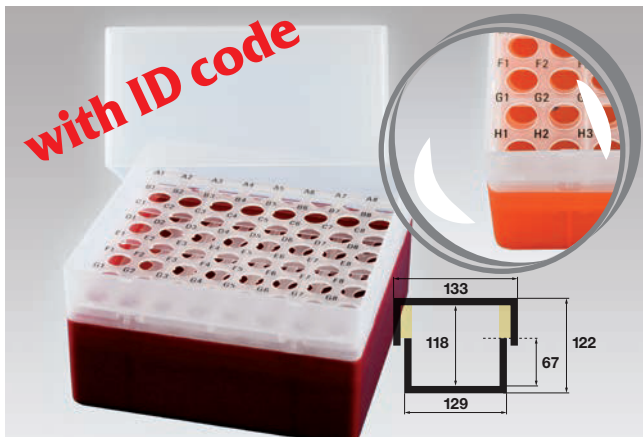

EPPi® 122 / 8x8 • height 122 mm fix

Inner height 118 mm. With two hole inserts 8x8 holes for 64 tubes up to 11 mm Ø. With alphanumeric ID code.

Cat. No.	Colour	Cat. No.	Colour
KEB122-C064NA	natural	KEB122-C064YE	yellow
KEB122-C064NY	neon-yellow	KEB122-C064BU	blue
KEB122-C064NB	neon-blue	KEB122-C064GR	green
KEB122-C064NG	neon-green	KEB122-C064RE	red
KEB122-C064NP	neon-red/pink	KEB122-C064VT	violet
KEB122-C064NO	neon-orange	KEB122-C064BL	black
KEB122-C064WH	white	KEB122-C064BB	black/black*

*black/black: Lower half and lid black for light-sensitive samples

Matching Racks

Vertical Racks
page 39

Horizontal Racks
page 40-41

Drawer Racks
page 46

Upright Bins
page 47



EPPi® 122 / 7x7 • height 122 mm fix

Inner height 118 mm. With two hole inserts 7x7 holes for 49 tubes up to 16.5 mm Ø. With alphanumeric ID code.

Cat. No.	Colour	Cat. No.	Colour
KEB122-C049NA	natural	KEB122-C049YE	yellow
KEB122-C049NY	neon-yellow	KEB122-C049BU	blue
KEB122-C049NB	neon-blue	KEB122-C049GR	green
KEB122-C049NG	neon-green	KEB122-C049RE	red
KEB122-C049NP	neon-red/pink	KEB122-C049VT	violet
KEB122-C049NO	neon-orange	KEB122-C049BL	black
KEB122-C049WH	white	KEB122-C049BB	black/black*

*black/black: Lower half and lid black for light-sensitive samples

Matching Racks

Vertical Racks
page 39

Horizontal Racks
page 40-41

Drawer Racks
page 46

Upright Bins
page 47

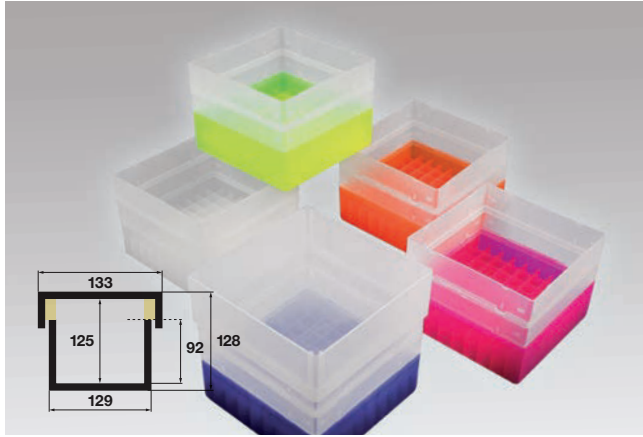

EPPi® 128 / 9x9 • height 128 mm fix

Inner height 125 mm. 9x9 divider holds 81 tubes up to 12.5 mm Ø. Without ID code.

Cat. No.	Colour	Cat. No.	Colour
KEA128-C81NA	natural	KEA128-C81YE	yellow
KEA128-C81NY	neon-yellow	KEA128-C81BU	blue
KEA128-C81NB	neon-blue	KEA128-C81GR	green
KEA128-C81NG	neon-green	KEA128-C81RE	red
KEA128-C81NP	neon-red/pink	KEA128-C81VT	violet
KEA128-C81NO	neon-orange	KEA128-C81BL	black
KEA128-C81WH	white	KEA128-C81BB	black/black*

*black/black: Lower half and lid black for light-sensitive samples

Matching Racks

Vertical Racks
page 39
Horizontal Racks
page 40–41
Drawer Racks
page 46
Upright Bins
page 47

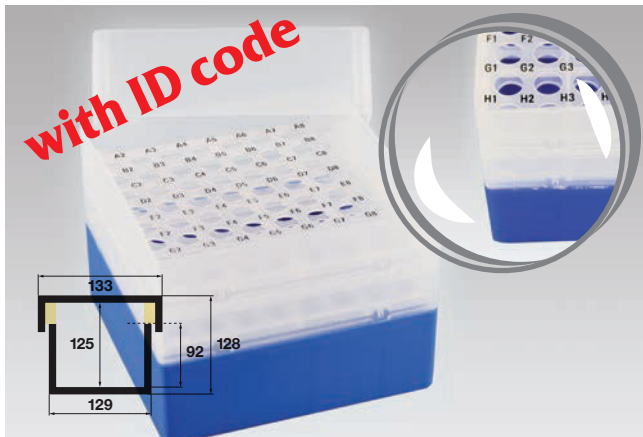

EPPi® 128 / 8x8 • height 128 mm fix

Inner height 125 mm. With two hole inserts 8x8 holes for 64 tubes up to 11 mm Ø. With alphanumeric ID code.

Cat. No.	Colour	Cat. No.	Colour
KEB128-C064NA	natural	KEB128-C064YE	yellow
KEB128-C064NY	neon-yellow	KEB128-C064BU	blue
KEB128-C064NB	neon-blue	KEB128-C064GR	green
KEB128-C064NG	neon-green	KEB128-C064RE	red
KEB128-C064NP	neon-red/pink	KEB128-C064VT	violet
KEB128-C064NO	neon-orange	KEB128-C064BL	black
KEB128-C064WH	white	KEB128-C064BB	black/black*

*black/black: Lower half and lid black for light-sensitive samples

Matching Racks

Vertical Racks
page 39
Horizontal Racks
page 40–41
Drawer Racks
page 46
Upright Bins
page 47

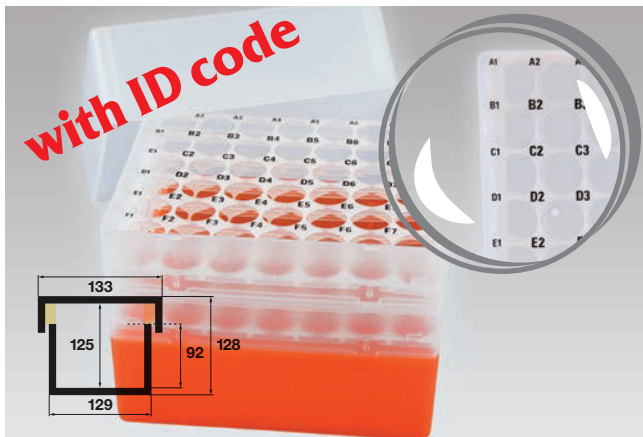

EPPi® 128 / 7x7 • height 128 mm fix

Inner height 125 mm. With two hole inserts 7x7 holes for 49 tubes up to 16.5 mm Ø. With alphanumeric ID code. (See also page 8: KEA128-C49..).

Cat. No.	Colour	Cat. No.	Colour
KEB128-C049NA	natural	KEB128-C049YE	yellow
KEB128-C049NY	neon-yellow	KEB128-C049BU	blue
KEB128-C049NB	neon-blue	KEB128-C049GR	green
KEB128-C049NG	neon-green	KEB128-C049RE	red
KEB128-C049NP	neon-red/pink	KEB128-C049VT	violet
KEB128-C049NO	neon-orange	KEB128-C049BL	black
KEB128-C049WH	white	KEB128-C049BB	black/black*

*black/black: Lower half and lid black for light-sensitive samples

Matching Racks

Vertical Racks
page 39
Horizontal Racks
page 40–41
Drawer Racks
page 46
Upright Bins
page 47



Photo: 34-1

Photo: 34-2

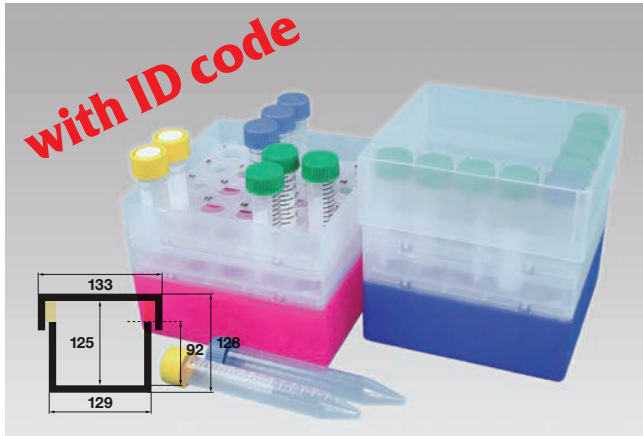

EPPi® 128 / 5x5 • height 128 mm fix

Inner height 125 mm. With two hole inserts 5x5 for 25 centrifuge tubes 15 ml (up to 17 mm Ø). With numeric ID code. Alphanumeric ID code on request.

Cat. No.	Colour	Cat. No.	Colour
KES128-C025NA	natural	KES128-C025YE	yellow
KES128-C025NY	neon-yellow	KES128-C025BU	blue
KES128-C025NB	neon-blue	KES128-C025GR	green
KES128-C025NG	neon-green	KES128-C025RE	red
KES128-C025NP	neon-red/pink	KES128-C025VT	violet
KES128-C025NO	neon-orange	KES128-C025BL	black
KES128-C025WH	white	KES128-C025BB	black/black*

*black/black: Lower half and lid black for light-sensitive samples

Matching Racks

Vertical Racks
page 39
Horizontal Racks
page 40–41
Drawer Racks
page 46
Upright Bins
page 47



EPPi® 128 / 3x3 • height 128 mm fix

Inner height 125 mm. With two hole inserts 3x3 holes for 9 centrifuge tubes 50 ml (up to 30 mm Ø). With numeric ID code. Alphanumeric ID code on request.

Cat. No.	Colour	Cat. No.	Colour
KES128-C09NA	natural	KES128-C09YE	yellow
KES128-C09NY	neon-yellow	KES128-C09BU	blue
KES128-C09NB	neon-blue	KES128-C09GR	green
KES128-C09NG	neon-green	KES128-C09RE	red
KES128-C09NP	neon-red/pink	KES128-C09VT	violet
KES128-C09NO	neon-orange	KES128-C09BL	black
KES128-C09WH	white	KES128-C09BB	black/black*

*black/black: Lower half and lid black for light-sensitive samples

Matching Racks

Vertical Racks
page 39
Horizontal Racks
page 40–41
Drawer Racks
page 46
Upright Bins
page 47

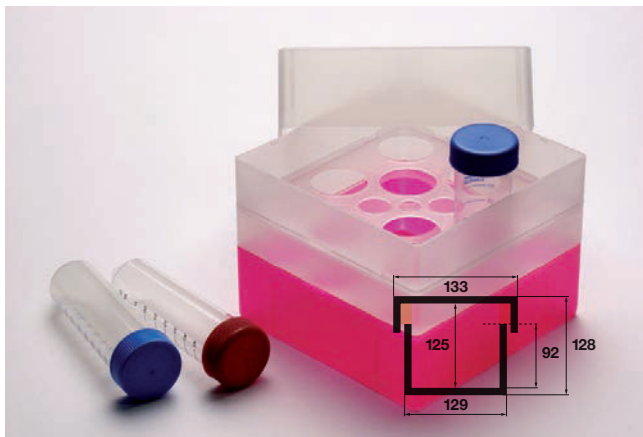

EPPi® 128 / 10 L • height 128 mm fix

Inner height 125 mm. With two hole inserts for 10 centrifuge tubes 50 ml (up to 30 mm Ø). Without ID code.

Cat. No.	Colour	Cat. No.	Colour
KEA128-C010NA	natural	KEA128-C010YE	yellow
KEA128-C010NY	neon-yellow	KEA128-C010BU	blue
KEA128-C010NB	neon-blue	KEA128-C010GR	green
KEA128-C010NG	neon-green	KEA128-C010RE	red
KEA128-C010NP	neon-red/pink	KEA128-C010VT	violet
KEA128-C010NO	neon-orange	KEA128-C010BL	black
KEA128-C010WH	white	KEA128-C010BB	black/black*

*black/black: Lower half and lid black for light-sensitive samples

Matching Racks

Vertical Racks
page 39
Horizontal Racks
page 40–41
Drawer Racks
page 46
Upright Bins
page 47



EPPi® 67 / 5x5 • height 67 mm fix

Inner height 64 mm. With two hole inserts 5x5 holes for 25 reaction vessels or centrifuge tubes 5 ml and tubes up to 16.6 mm Ø. With numeric ID code. Alphanumeric ID code on request.

Cat. No.	Colour	Cat. No.	Colour
KES67-C025NA	natural	KES67-C025YE	yellow
KES67-C025NY	neon-yellow	KES67-C025BU	blue
KES67-C025NB	neon-blue	KES67-C025GR	green
KES67-C025NG	neon-green	KES67-C025RE	red
KES67-C025NP	neon-red/pink	KES67-C025VT	violet
KES67-C025NO	neon-orange	KES67-C025BL	black
KES67-C025WH	white	KES67-C025BB	black/black*

*black/black: Lower half and lid black for light-sensitive samples

Matching Racks

Vertical Racks
Please request!
Horizontal Racks
Please request!
Drawer Racks
Please request!
Upright Bins
page 47

EPPi® Box made of Polypropylene

130 x 130 mm

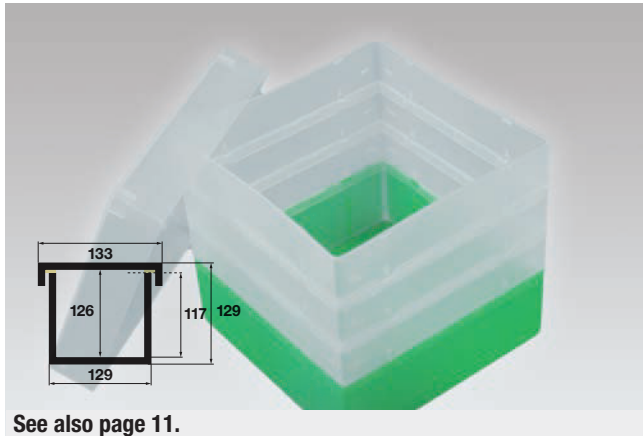

EPPi® 129 / 1x1 • height 129 mm fix

Inner height 126 mm. Without grid divider. Useful for EPPi® hole inserts or grid dividers (page 37).

Cat. No.	Colour	Cat. No.	Colour
KEA129-C1NA	natural	KEA129-C1YE	yellow
KEA129-C1NY	neon-yellow	KEA129-C1BU	blue
KEA129-C1NB	neon-blue	KEA129-C1GR	green
KEA129-C1NG	neon-green	KEA129-C1RE	red
KEA129-C1NP	neon-red/pink	KEA129-C1VT	violet
KEA129-C1NO	neon-orange	KEA129-C1BL	black
KEA129-C1WH	white	KEA129-C1BB	black/black*

*black/black: Lower half and lid black for light-sensitive samples

Matching Racks

Vertical Racks
Please request!

Horizontal Racks
Please request!

Drawer Racks
Please request!

Upright Bins
page 47

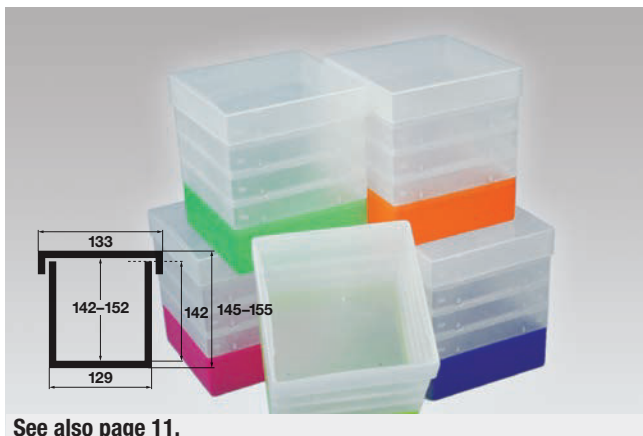

EPPi® 145 / 1x1 • height 145-155 mm variable

Without grid divider. Useful for EPPi® hole inserts or grid dividers (page 37).

Cat. No.	Colour	Cat. No.	Colour
KEA145-V1NA	natural	KEA145-V1YE	yellow
KEA145-V1NY	neon-yellow	KEA145-V1BU	blue
KEA145-V1NB	neon-blue	KEA145-V1GR	green
KEA145-V1NG	neon-green	KEA145-V1RE	red
KEA145-V1NP	neon-red/pink	KEA145-V1VT	violet
KEA145-V1NO	neon-orange	KEA145-V1BL	black
KEA145-V1WH	white	KEA145-V1BB	black/black*

*black/black: Lower half and lid black for light-sensitive samples

Matching Racks

Vertical Racks
Please request!

Horizontal Racks
Please request!

Drawer Racks
Please request!

Upright Bins
page 47

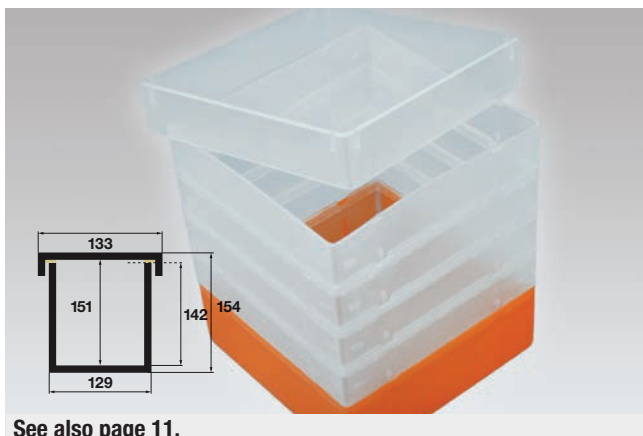

EPPi® 154 • height 154 mm fix

Inner height 151 mm. Without grid divider. Useful for EPPi® hole inserts or grid dividers (page 37).

Cat. No.	Colour	Cat. No.	Colour
KEA154-C1NA	natural	KEA154-C1YE	yellow
KEA154-C1NY	neon-yellow	KEA154-C1BU	blue
KEA154-C1NB	neon-blue	KEA154-C1GR	green
KEA154-C1NG	neon-green	KEA154-C1RE	red
KEA154-C1NP	neon-red/pink	KEA154-C1VT	violet
KEA154-C1NO	neon-orange	KEA154-C1BL	black
KEA154-C1WH	white	KEA154-C1BB	black/black*

*black/black: Lower half and lid black for light-sensitive samples

Matching Racks

Vertical Racks
Please request!

Horizontal Racks
Please request!

Drawer Racks
Please request!

Upright Bins
page 47

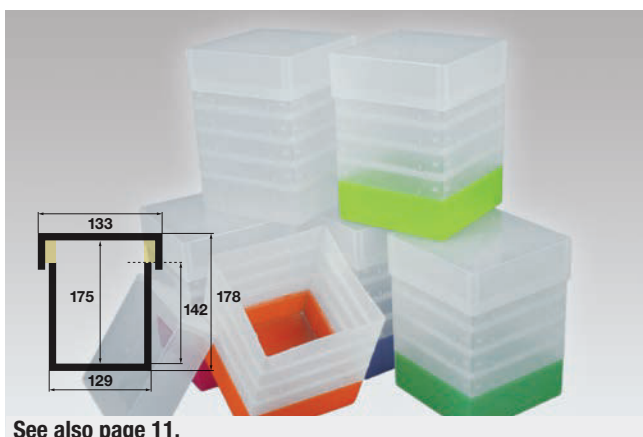

EPPi® 178 • height 178 mm fix

Inner height 175 mm. Without grid divider. Useful for EPPi® hole inserts or grid dividers (page 37).

Cat. No.	Colour	Cat. No.	Colour
KEA178-C1NA	natural	KEA178-C1YE	yellow
KEA178-C1NY	neon-yellow	KEA178-C1BU	blue
KEA178-C1NB	neon-blue	KEA178-C1GR	green
KEA178-C1NG	neon-green	KEA178-C1RE	red
KEA178-C1NP	neon-red/pink	KEA178-C1VT	violet
KEA178-C1NO	neon-orange	KEA178-C1BL	black
KEA178-C1WH	white	KEA178-C1BB	black/black*

*black/black: Lower half and lid black for light-sensitive samples

Matching Racks

Vertical Racks
Please request!

Horizontal Racks
Please request!

Drawer Racks
Please request!

Upright Bins
page 47

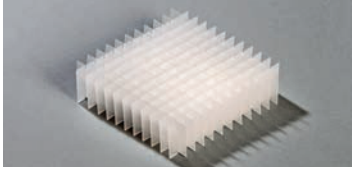
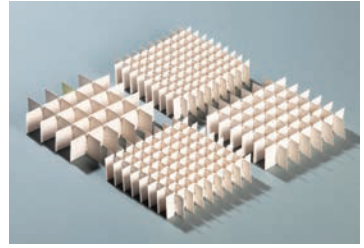
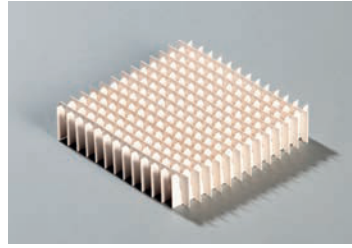
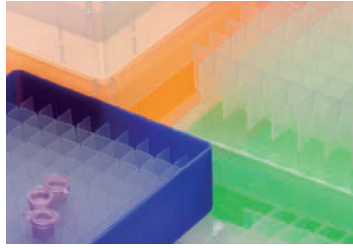
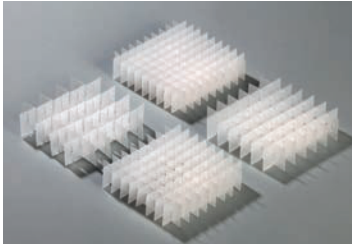

Grid Dividers for EPPi® Box

and all boxes 130 x 130 mm / 133 x 133 mm

K = Polypropylene (PP)
N = Fiberboard

Cells for Tubes	Heights					
	15 mm	25 mm	30 mm	40 mm	65 mm	80 mm
	Cat. No.	Cat. No.	Cat. No.	Cat. No.	Cat. No.	Cat. No.
16x16 up to ca. 7.2 mm Ø	RB10151616N	RB10251616N	RB10301616N	RB10401616N	RB10651616N	RB10801616N
15x15 up to ca. 7.7 mm Ø	RB10151515N	RB10251515N	RB10301515N	RB10401515N	RB10651515N	RB10801515N
14x14 up to ca. 8.3 mm Ø	RB10151414N	RB10251414N	RB10301414N	RB10401414N	RB10651414N	RB10801414N
13x13 up to ca. 9.0 mm Ø	RB10151313N	RB10251313N	RB10301313N	RB10401313N	RB10651313N	RB10801313N
12x12 up to ca. 9.8 mm Ø	RB10151212N	RB10251212N	RE10301212K	RB10401212N	RB10651212N	RB10801212N
11x11 up to ca. 10.8 mm Ø	RB10151111N	RB10251111N	RB10301111N	RB10401111N	RB10651111N	RB10801111N
10x10 up to ca. 12.0 mm Ø	RB10151010N	RB10251010N	RE10301010K	RB10401010N	RB10651010N	RB10801010N
9x9 up to ca. 13.0 mm Ø	RB10150909N	RB10250909N	RE10300909K	RB10400909N	RB10650909N	RB10800909N
8x8 up to ca. 15.0 mm Ø	RB10150808N	RB10250808N	RE10300808K	RB10400808N	RB10650808N	RB10800808N
7x7 up to ca. 17.3 mm Ø	RB10150707N	RB10250707N	RE10300707K	RB10400707N	RB10650707N	RB10800707N
6x6 up to ca. 20.3 mm Ø	RB10150606N	RB10250606N	RE10300606K	RB10400606N	RB10650606N	RB10800606N
5x5 up to ca. 24.5 mm Ø	RB10150505N	RB10250505N	RE10300505K	RB10400505N	RB10650505N	RB10800505N
4x4 up to ca. 30.8 mm Ø	RB10150404N	RB10250404N	RE10300404K	RB10400404N	RB10650404N	RB10800404N
3x3 up to ca. 41.2 mm Ø	RB10150303N	RB10250303N	RE10300303K	RB10400303N	RB10650303N	RB10800303N

The 30 mm high EPPi grid dividers Cat. No. RE1030.. can also be stacked on top of each other when higher boxes are used.

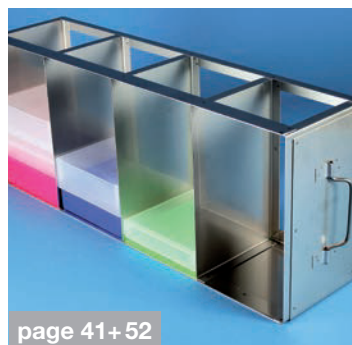

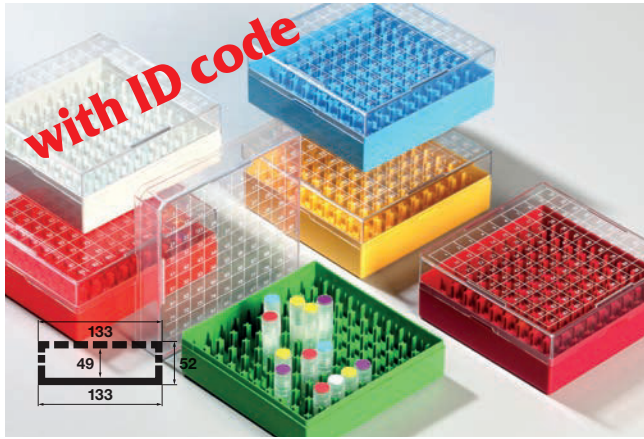

Thorbi® Cryobox 100 / 10x10 • height 52 mm fix

Thorbi® Cryobox 100-place made of extra strong polycarbonate. For 10x10 EPPi® cryo tubes 0.5 up to 2.0 ml with male thread or ordinary cryo tubes with female thread. Transparent lid with numeric ID code (1-100). 133x133x52 mm (WxDxH).

Cat. No.	Colour	Cells	for Tubes	Height
KPC50-C100WH	white	10x10	0.5 up to 2.0 ml	52 mm
KPC50-C100BU	blue	10x10	0.5 up to 2.0 ml	52 mm
KPC50-C100YE	yellow	10x10	0.5 up to 2.0 ml	52 mm
KPC50-C100GR	green	10x10	0.5 up to 2.0 ml	52 mm
KPC50-C100RE	red	10x10	0.5 up to 2.0 ml	52 mm
KPC50-C100OR	orange	10x10	0.5 up to 2.0 ml	52 mm

Matching Racks

Vertical Racks
page 39

Horizontal Racks
page 40–41

Drawer Racks
page 42–43

Upright Bins
page 47

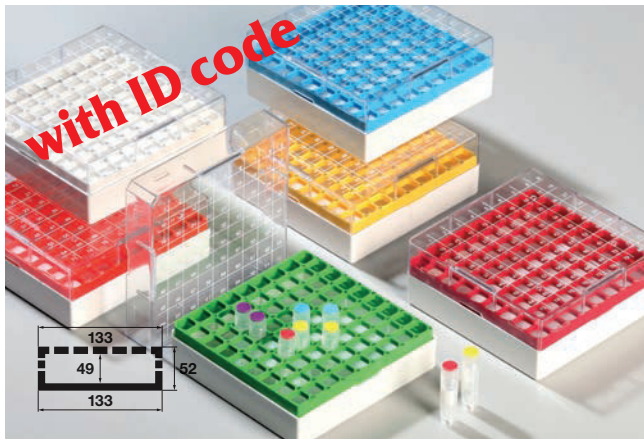

Thorbi® Cryobox 81 / 9x9 • height 52 mm fix

Thorbi® Cryobox 81-place made of extra strong polycarbonate. For 9x9 cryo tubes 2.0 ml. Transparent lid with numeric ID code (1-81). 133x133x52 mm (WxDxH).

Cat. No.	Colour	Cells	for Tubes	Height
KPC50-C81WH	white	9x9	2.0 ml	52 mm
KPC50-C81BU	blue	9x9	2.0 ml	52 mm
KPC50-C81YE	yellow	9x9	2.0 ml	52 mm
KPC50-C81GR	green	9x9	2.0 ml	52 mm
KPC50-C81RE	red	9x9	2.0 ml	52 mm
KPC50-C81OR	orange	9x9	2.0 ml	52 mm

Matching Racks

Vertical Racks
page 39

Horizontal Racks
page 40–41

Drawer Racks
page 42–43

Upright Bins
page 47

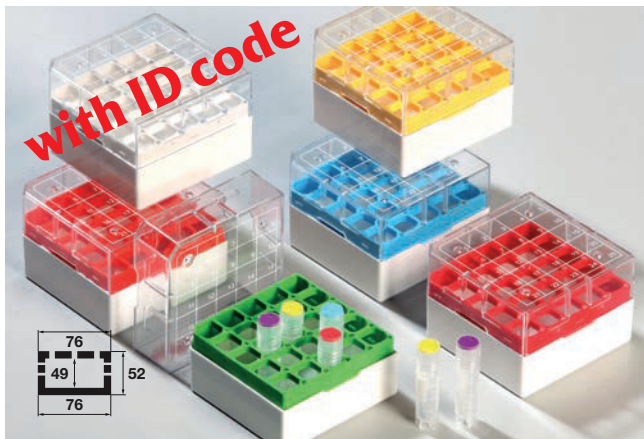

Thorbi® Cryobox 25 / 5x5 • height 52 mm fix

Thorbi® Cryobox 25-place made of extra strong polycarbonate. For 5x5 cryo tubes 2.0 ml. Transparent lid with numeric ID code (1-25). 76x76x52 mm (WxDxH).

Cat. No.	Colour	Cells	for Tubes	Height
KPC50-C25WH	white	5x5	2.0 ml	52 mm
KPC50-C25BU	blue	5x5	2.0 ml	52 mm
KPC50-C25YE	yellow	5x5	2.0 ml	52 mm
KPC50-C25GR	green	5x5	2.0 ml	52 mm
KPC50-C25RE	red	5x5	2.0 ml	52 mm
KPC50-C25OR	orange	5x5	2.0 ml	52 mm

Matching Racks

Vertical Racks
page 69

Horizontal Racks
page 69

Drawer Racks
Please request!

Upright Bins
page 47 + 53

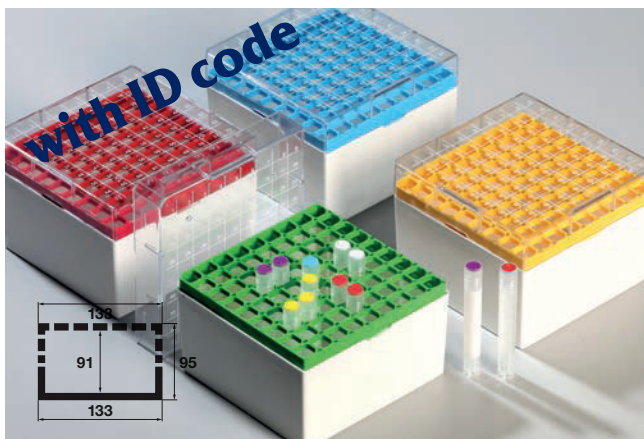

Thorbi® Cryobox 81H / 9x9 • height 95 mm fix

Thorbi® Cryobox 81-place made of extra strong polycarbonate. For 9x9 cryo tubes 5.0 ml. Transparent lid with numeric ID code (1-81). 133x133x95 mm (WxDxH).

Cat. No.	Colour	Cells	for Tubes	Height
KPC95-C81BU	blue	9x9	5.0 ml	95 mm
KPC95-C81YE	yellow	9x9	5.0 ml	95 mm
KPC95-C81GR	green	9x9	5.0 ml	95 mm
KPC95-C81RE	red	9x9	5.0 ml	95 mm

Matching Racks

Vertical Racks
page 39

Horizontal Racks
page 40–41

Drawer Racks
page 45

Upright Bins
page 47



EPPi® 32 Vertical Racks

Useful for EPPi® 32 and all boxes up to external dimensions 133x133x32 mm (WxDxH).
2 boxes in each bay,
total number in ().

Cat. No.	Bays	Height (mm)
TE32-08AN2	4 (8)	274
TE32-10AN2	5 (10)	341
TE32-12AN2	6 (12)	408
TE32-14AN2	7 (14)	475
TE32-16AN2	8 (16)	542
TE32-18AN2	9 (18)	609
TE32-20AN2	10 (20)	676



EPPi® 37 Vertical Racks

Useful for EPPi® 37 and all boxes up to external dimensions 133x133x37 mm (WxDxH).

Cat. No.	Bays	Height (mm)
TE37-05AN	5	204
TE37-06AN	6	243
TE37-07AN	7	283
TE37-08AN	8	322
TE37-09AN	9	362
TE37-10AN	10	401
TE37-11AN	11	441
TE37-12AN	12	480
TE37-13AN	13	520
TE37-14AN	14	559
TE37-15AN	15	599
TE37-16AN	16	638
TE37-17AN	17	678
TE37-18AN	18	717

EPPi® 45 + 50 Vertical Racks

Useful for EPPi® 45+50 and all boxes up to external dimensions 133x133x53 mm (WxDxH).

Cat. No.	Bays	Height (mm)
TE50-04AN	4	226
TE50-05AN	5	281
TE50-06AN	6	336
TE50-07AN	7	391
TE50-08AN	8	446
TE50-09AN	9	501
TE50-10AN	10	556
TE50-11AN	11	611
TE50-12AN	12	666
TE50-13AN	13	721
TE50-14AN	14	776

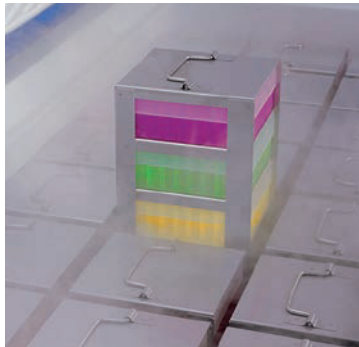

EPPi® 70 + 75 Vertical Racks

Useful for EPPi® 70+75 and all boxes up to external dimensions 133x133x76 mm (WxDxH).

Cat. No.	Bays	Height (mm)
TE75-03AN	3	242
TE75-04AN	4	320
TE75-05AN	5	399
TE75-06AN	6	477
TE75-07AN	7	556
TE75-08AN	8	634
TE75-09AN	9	713

EPPi® 80 Vertical Racks

Useful for EPPi® 80 and all boxes up to external dimensions 133x133x80 mm (WxDxH).

Cat. No.	Bays	Height (mm)
TE80-03AN	3	252
TE80-04AN	4	334
TE80-05AN	5	416
TE80-06AN	6	498
TE80-07AN	7	580
TE80-08AN	8	662
TE80-09AN	9	744

EPPi® 95 + 96 Vertical Racks

Useful for EPPi® 95+96 and all boxes up to external dimensions 133x133x97 mm (WxDxH).

Cat. No.	Bays	Height (mm)
TE96-03AN	3	303
TE96-04AN	4	402
TE96-05AN	5	501
TE96-06AN	6	600
TE96-07AN	7	699



EPPi® 102 Vertical Racks

Useful for EPPi® 102 and all boxes up to external dimensions 133x133x103 mm (WxDxH).

Cat. No.	Bays	Height (mm)
TE102-03AN	3	321
TE102-04AN	4	426
TE102-05AN	5	531
TE102-06AN	6	636
TE102-07AN	7	741

EPPi® 105 Vertical Racks

Useful for EPPi® 105 and all boxes up to external dimensions 133x133x105 mm (WxDxH).

Cat. No.	Bays	Height (mm)
TE105-02AN	2	220
TE105-03AN	3	327
TE105-04AN	4	434
TE105-05AN	5	541
TE105-06AN	6	648

EPPi® 122 + 128 Vertical Racks

Useful for EPPi® 122+128 and all boxes up to external dimensions 133x133x128 mm (WxDxH).

Cat. No.	Bays	Height (mm)
TE128-02AN	2	267
TE128-03AN	3	398
TE128-04AN	4	528
TE128-05AN	5	659



Folding handle positioned crosswise as standard.
Alternatives: Folding handle positioned lengthwise or hand grip.
Please enquire if needed.



All vertical racks can be supplied with a safety rod if required.
This increases the depth by 7 mm to 145 mm.
Please enquire if needed.

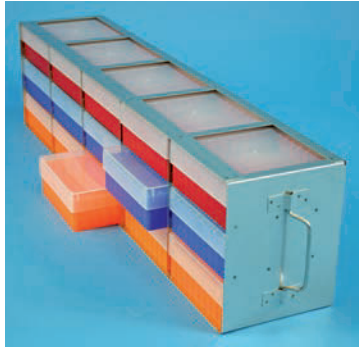

EPPi® 32 Horizontal Racks

Useful for EPPi® 32 and all boxes up to external dimensions 133x133x32 mm (WxDxH).
2 boxes in each bay, total number in ().

Cat. No.	Bays Depth x Height	Dimensions D x H (mm)
SE32-36AN2	3x3 (18)	414x205
SE32-38AN2	3x4 (24)	414x272
SE32-46AN2	4x3 (24)	549x205
SE32-48AN2	4x4 (32)	549x272
SE32-56AN2	5x3 (30)	685x205
SE32-58AN2	5x4 (40)	685x272



EPPi® 37 Horizontal Racks

Useful for EPPi® 37 and all boxes up to external dimensions 133x133x37 mm (WxDxH).

Cat. No.	Bays Depth x Height	Dimensions D x H (mm)
SE37-36AN	3 x 6	414x241
SE37-37AN	3 x 7	414x280
SE37-38AN	3 x 8	414x320
SE37-39AN	3 x 9	414x359
SE37-45AN	4 x 5	549x201
SE37-46AN	4 x 6	549x241
SE37-47AN	4 x 7	549x280
SE37-48AN	4 x 8	549x320
SE37-49AN	4 x 9	549x359
SE37-55AN	5 x 5	685x201
SE37-56AN	5 x 6	685x241
SE37-57AN	5 x 7	685x280
SE37-58AN	5 x 8	685x320
SE37-59AN	5 x 9	685x359



Folding handle positioned vertically as standard.
Alternatives: Folding handle positioned horizontally or hand grip. Please enquire if needed.



EPPi® 70 + 75 Horizontal Racks

Useful for EPPi® 70+75 and all boxes up to external dimensions 133x133x76 mm (WxDxH).

Cat. No.	Bays Depth x Height	Dimensions D x H (mm)
SE75-32AN	3 x 2	414x161
SE75-33AN	3 x 3	414x239
SE75-34AN	3 x 4	414x318
SE75-42AN	4 x 2	549x161
SE75-43AN	4 x 3	549x239
SE75-44AN	4 x 4	549x318
SE75-52AN	5 x 2	685x161
SE75-53AN	5 x 3	685x239
SE75-54AN	5 x 4	685x318



EPPi® 80 Horizontal Racks

Useful for EPPi® 80 and all boxes up to external dimensions 133x133x80 mm (WxDxH).

Cat. No.	Bays Depth x Height	Dimensions D x H (mm)
SE80-32AN	3 x 2	414x168
SE80-33AN	3 x 3	414x250
SE80-34AN	3 x 4	414x332
SE80-42AN	4 x 2	549x168
SE80-43AN	4 x 3	549x250
SE80-44AN	4 x 4	549x332
SE80-52AN	5 x 2	685x168
SE80-53AN	5 x 3	685x250
SE80-54AN	5 x 4	685x332

EPPi® 102 Horizontal Racks

Useful for EPPi® 102 and all boxes up to external dimensions 133x133x103 mm (WxDxH).

Cat. No.	Bays Depth x Height	Dimensions D x H (mm)
SE102-32AN	3 x 2	414x214
SE102-33AN	3 x 3	414x319
SE102-42AN	4 x 2	549x214
SE102-43AN	4 x 3	549x319
SE102-52AN	5 x 2	685x214
SE102-53AN	5 x 3	685x319

EPPi® 105 Horizontal Racks

Useful for EPPi® 105 and all boxes up to external dimensions 133x133x105 mm (WxDxH).

Cat. No.	Bays Depth x Height	Dimensions D x H (mm)
SE105-32AN	3 x 2	414x218
SE105-33AN	3 x 3	414x325
SE105-42AN	4 x 2	549x218
SE105-43AN	4 x 3	549x325
SE105-52AN	5 x 2	685x218
SE105-53AN	5 x 3	685x325

EPPi® 45 + 50 Horizontal Racks

Useful for EPPi® 45+50 and all boxes up to external dimensions 133x133x53 mm (WxDxH).

Cat. No.	Bays Depth x Height	Dimensions D x H (mm)
SE50-24AN	2 x 4	278x224
SE50-25AN	2 x 5	278x279
SE50-26AN	2 x 6	278x334
SE50-33AN	3 x 3	414x169
SE50-34AN	3 x 4	414x224
SE50-35AN	3 x 5	414x279
SE50-36AN	3 x 6	414x334
SE50-37AN	3 x 7	414x389
SE50-43AN	4 x 3	549x169
SE50-44AN	4 x 4	549x224
SE50-45AN	4 x 5	549x279
SE50-46AN	4 x 6	549x334
SE50-47AN	4 x 7	549x389
SE50-53AN	5 x 3	685x169
SE50-54AN	5 x 4	685x224
SE50-55AN	5 x 5	685x279
SE50-56AN	5 x 6	685x334
SE50-57AN	5 x 7	685x389

EPPi® 95 + 96 Horizontal Racks

Useful for EPPi® 95+96 and all boxes up to external dimensions 133x133x97 mm (WxDxH).

Cat. No.	Bays Depth x Height	Dimensions D x H (mm)
SE96-32AN	3 x 2	414x202
SE96-33AN	3 x 3	414x301
SE96-42AN	4 x 2	549x202
SE96-43AN	4 x 3	549x301
SE96-52AN	5 x 2	685x202
SE96-53AN	5 x 3	685x301

EPPi® 122 + 128 Horizontal Racks

Useful for EPPi® 122+128 and all boxes up to external dimensions 133x133x128 mm (WxDxH).

Cat. No.	Bays Depth x Height	Dimensions D x H (mm)
SE128-32AN	3 x 2	414x265
SE128-33AN	3 x 3	414x395
SE128-42AN	4 x 2	549x265
SE128-43AN	4 x 3	549x395
SE128-52AN	5 x 2	685x265
SE128-53AN	5 x 3	685x395



All horizontal racks can be supplied with safety rods if required.
Add 7 mm to width and 3 mm to height.
Please enquire if needed.



EPPi® Horizontal Racks without intermediate shelf

For EPPi® boxes of different heights. Also useful for boxes with external dimensions of up to 133 x 133 mm (WxD).

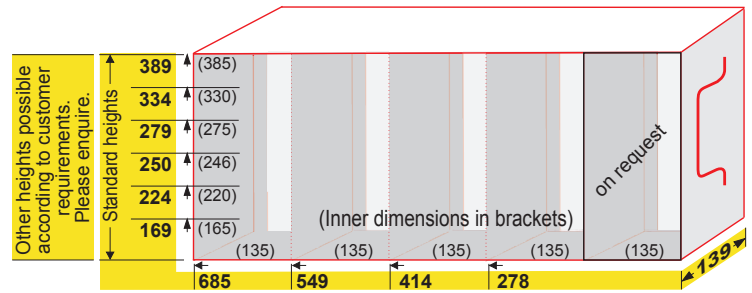

Standard Heights

Cat. No.	Bays Depth x Height	Inner Height Bay (mm)	Dimensions D x H (mm)
SEX169-2-01AN	2 x 1	165	278x169
SEX169-3-01AN	3 x 1	165	414x169
SEX169-4-01AN	4 x 1	165	549x169
SEX169-5-01AN	5 x 1	165	685x169
SEX224-2-01AN	2 x 1	220	278x224
SEX224-3-01AN	3 x 1	220	414x224
SEX224-4-01AN	4 x 1	220	549x224
SEX224-5-01AN	5 x 1	220	685x224
SEX250-2-01AN	2 x 1	246	278x250
SEX250-3-01AN	3 x 1	246	414x250
SEX250-4-01AN	4 x 1	246	549x250
SEX250-5-01AN	5 x 1	246	685x250

Standard Heights

Cat. No.	Bays Depth x Height	Inner Height Bay (mm)	Dimensions D x H (mm)
SEX279-2-01AN	2 x 1	275	278x279
SEX279-3-01AN	3 x 1	275	414x279
SEX279-4-01AN	4 x 1	275	549x279
SEX279-5-01AN	5 x 1	275	685x279
SEX334-2-01AN	2 x 1	330	278x334
SEX334-3-01AN	3 x 1	330	414x334
SEX334-4-01AN	4 x 1	330	549x334
SEX334-5-01AN	5 x 1	330	685x334
SEX389-2-01AN	2 x 1	385	278x389
SEX389-3-01AN	3 x 1	385	414x389
SEX389-4-01AN	4 x 1	385	549x389
SEX389-5-01AN	5 x 1	385	685x389



EPPi® Horizontal Racks with one intermediate shelf

For EPPi® boxes of different heights. Also useful for boxes with external dimensions of up to 133 x 133 mm (WxD).

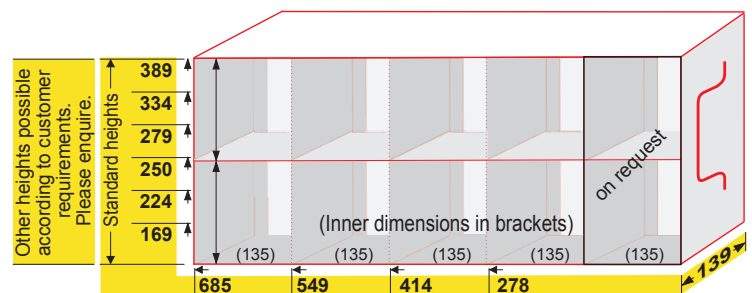

Standard Heights

Cat. No.	Bays Depth x Height	Inner Height Bay (mm)	Dimensions D x H (mm)
SEX169-2-02AN	2x2	82	278x169
SEX169-3-02AN	3x2	82	414x169
SEX169-4-02AN	4x2	82	549x169
SEX169-5-02AN	5x2	82	685x169
SEX224-2-02AN	2x2	109	278x224
SEX224-3-02AN	3x2	109	414x224
SEX224-4-02AN	4x2	109	549x224
SEX224-5-02AN	5x2	109	685x224
SEX250-2-02AN	2x2	122	278x250
SEX250-3-02AN	3x2	122	414x250
SEX250-4-02AN	4x2	122	549x250
SEX250-5-02AN	5x2	122	685x250

Standard Heights

Cat. No.	Bays Depth x Height	Inner Height Bay (mm)	Dimensions D x H (mm)
SEX279-2-02AN	2x2	137	278x279
SEX279-3-02AN	3x2	137	414x279
SEX279-4-02AN	4x2	137	549x279
SEX279-5-02AN	5x2	137	685x279
SEX334-2-02AN	2x2	164	278x334
SEX334-3-02AN	3x2	164	414x334
SEX334-4-02AN	4x2	164	549x334
SEX334-5-02AN	5x2	164	685x334
SEX389-2-02AN	2x2	192	278x389
SEX389-3-02AN	3x2	192	414x389
SEX389-4-02AN	4x2	192	549x389
SEX389-5-02AN	5x2	192	685x389



Folding handle positioned vertically as standard.

Alternatives: Folding handle positioned horizontally or hand grip. Please enquire if needed.



All horizontal racks can be supplied with safety rods if required. Add 7 mm to width and 3 mm to height. Please enquire if needed.

With Folding Handle Open Design



Please complete item number:

L Base of drawer with center opening.
Facilitates removal and insertion.

V Base of drawer closed.



With Folding Handle Closed Design

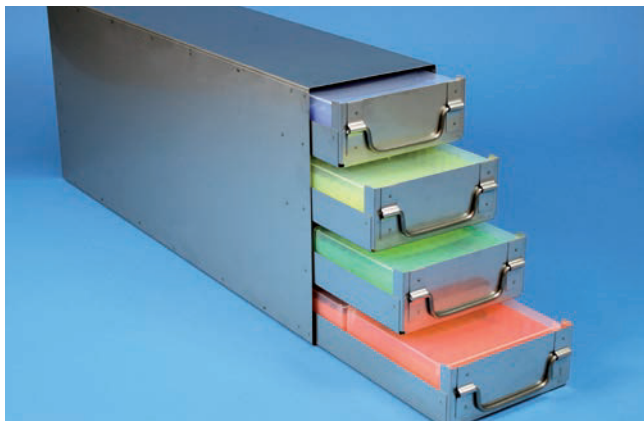

Please complete item number:

L Base of drawer with center opening.
Facilitates removal and insertion.

V Base of drawer closed.

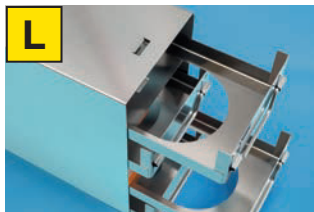

EPPi® 45 + 50 Drawer Racks • with Folding Handle

Useful for EPPi® 45 + 50 and all boxes up to external dimensions 133x133x53 mm (WxDxH). Front closed.

Cat. No.	With Safety Stop		DxH (mm)
	L V	Number Depth Height	
SE50-22NAM	2	2	301 x 123
SE50-23NAM	2	3	301 x 184
SE50-24NAM	2	4	301 x 245
SE50-25NAM	2	5	301 x 306
SE50-26NAM	2	6	301 x 367
SE50-27NAM	2	7	301 x 428
SE50-32NAM	3	2	434 x 123
SE50-33NAM	3	3	434 x 184
SE50-34NAM	3	4	434 x 245
SE50-35NAM	3	5	434 x 306
SE50-36NAM	3	6	434 x 367
SE50-37NAM	3	7	434 x 428
SE50-42NAM	4	2	567 x 123
SE50-43NAM	4	3	567 x 184
SE50-44NAM	4	4	567 x 245
SE50-45NAM	4	5	567 x 306
SE50-46NAM	4	6	567 x 367
SE50-47NAM	4	7	567 x 428
SE50-52NAM	5	2	700 x 123
SE50-53NAM	5	3	700 x 184
SE50-54NAM	5	4	700 x 245
SE50-55NAM	5	5	700 x 306
SE50-56NAM	5	6	700 x 367
SE50-57NAM	5	7	700 x 428

Cat. No.	Without Safety Stop		DxH (mm)
	L V	Number Depth Height	
SE50-22NAO	2	2	283 x 116
SE50-23NAO	2	3	283 x 173
SE50-24NAO	2	4	283 x 231
SE50-25NAO	2	5	283 x 288
SE50-26NAO	2	6	283 x 346
SE50-27NAO	2	7	283 x 403
SE50-32NAO	3	2	416 x 116
SE50-33NAO	3	3	416 x 173
SE50-34NAO	3	4	416 x 231
SE50-35NAO	3	5	416 x 288
SE50-36NAO	3	6	416 x 346
SE50-37NAO	3	7	416 x 403
SE50-42NAO	4	2	549 x 116
SE50-43NAO	4	3	549 x 173
SE50-44NAO	4	4	549 x 231
SE50-45NAO	4	5	549 x 288
SE50-46NAO	4	6	549 x 346
SE50-47NAO	4	7	549 x 403
SE50-52NAO	5	2	682 x 116
SE50-53NAO	5	3	682 x 173
SE50-54NAO	5	4	682 x 231
SE50-55NAO	5	5	682 x 288
SE50-56NAO	5	6	682 x 346
SE50-57NAO	5	7	682 x 403

EPPi® 45 + 50 Drawer Racks • with Folding Handle

Useful for EPPi® 45 + 50 and all boxes up to external dimensions 133x133x53 mm (WxDxH). Front closed.

Cat. No.	With Safety Stop		DxH (mm)
	L V	Number Depth Height	
SE50-22GAM	2	2	301 x 123
SE50-23GAM	2	3	301 x 184
SE50-24GAM	2	4	301 x 245
SE50-25GAM	2	5	301 x 306
SE50-26GAM	2	6	301 x 367
SE50-27GAM	2	7	301 x 428
SE50-32GAM	3	2	434 x 123
SE50-33GAM	3	3	434 x 184
SE50-34GAM	3	4	434 x 245
SE50-35GAM	3	5	434 x 306
SE50-36GAM	3	6	434 x 367
SE50-37GAM	3	7	434 x 428
SE50-42GAM	4	2	567 x 123
SE50-43GAM	4	3	567 x 184
SE50-44GAM	4	4	567 x 245
SE50-45GAM	4	5	567 x 306
SE50-46GAM	4	6	567 x 367
SE50-47GAM	4	7	567 x 428
SE50-52GAM	5	2	700 x 123
SE50-53GAM	5	3	700 x 184
SE50-54GAM	5	4	700 x 245
SE50-55GAM	5	5	700 x 306
SE50-56GAM	5	6	700 x 367
SE50-57GAM	5	7	700 x 428

Cat. No.	Without Safety Stop		DxH (mm)
	L V	Number Depth Height	
SE50-22GAO	2	2	283 x 116
SE50-23GAO	2	3	283 x 173
SE50-24GAO	2	4	283 x 231
SE50-25GAO	2	5	283 x 288
SE50-26GAO	2	6	283 x 346
SE50-27GAO	2	7	283 x 403
SE50-32GAO	3	2	416 x 116
SE50-33GAO	3	3	416 x 173
SE50-34GAO	3	4	416 x 231
SE50-35GAO	3	5	416 x 288
SE50-36GAO	3	6	416 x 346
SE50-37GAO	3	7	416 x 403
SE50-42GAO	4	2	549 x 116
SE50-43GAO	4	3	549 x 173
SE50-44GAO	4	4	549 x 231
SE50-45GAO	4	5	549 x 288
SE50-46GAO	4	6	549 x 346
SE50-47GAO	4	7	549 x 403
SE50-52GAO	5	2	682 x 116
SE50-53GAO	5	3	682 x 173
SE50-54GAO	5	4	682 x 231
SE50-55GAO	5	5	682 x 288
SE50-56GAO	5	6	682 x 346
SE50-57GAO	5	7	682 x 403

With Hand Grip Open Design



Please complete item number:

- B** Sides of the drawers approx. 10 mm high. Front with hand grip approx. 40 mm high. Examination of contents possible.
- F** Sides of the drawers approx. 20 mm high. Front with hand grip to max. height, closed. No examination of contents possible.

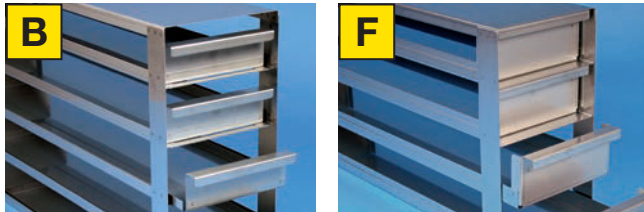

EPPi® 45 + 50 Drawer Racks • with Hand Grip

Useful for EPPi® 45 + 50 and all boxes up to external dimensions 133x133x53 mm (WxDxH). Base of drawers closed.

With Safety Stop			
Cat. No.	B	Number	DxH (mm)
	F		
SE50-22N	MV	2 2	301 x 123
SE50-23N	MV	2 3	301 x 184
SE50-24N	MV	2 4	301 x 245
SE50-25N	MV	2 5	301 x 306
SE50-26N	MV	2 6	301 x 367
SE50-27N	MV	2 7	301 x 428
SE50-32N	MV	3 2	434 x 123
SE50-33N	MV	3 3	434 x 184
SE50-34N	MV	3 4	434 x 245
SE50-35N	MV	3 5	434 x 306
SE50-36N	MV	3 6	434 x 367
SE50-37N	MV	3 7	434 x 428
SE50-42N	MV	4 2	567 x 123
SE50-43N	MV	4 3	567 x 184
SE50-44N	MV	4 4	567 x 245
SE50-45N	MV	4 5	567 x 306
SE50-46N	MV	4 6	567 x 367
SE50-47N	MV	4 7	567 x 428
SE50-52N	MV	5 2	700 x 123
SE50-53N	MV	5 3	700 x 184
SE50-54N	MV	5 4	700 x 245
SE50-55N	MV	5 5	700 x 306
SE50-56N	MV	5 6	700 x 367
SE50-57N	MV	5 7	700 x 428

Without Safety Stop			
Cat. No.	B	Number	DxH (mm)
	F		
SE50-22N	OV	2 2	301 x 116
SE50-23N	OV	2 3	301 x 173
SE50-24N	OV	2 4	301 x 231
SE50-25N	OV	2 5	301 x 288
SE50-26N	OV	2 6	301 x 346
SE50-27N	OV	2 7	301 x 403
SE50-32N	OV	3 2	434 x 116
SE50-33N	OV	3 3	434 x 173
SE50-34N	OV	3 4	434 x 231
SE50-35N	OV	3 5	434 x 288
SE50-36N	OV	3 6	434 x 346
SE50-37N	OV	3 7	434 x 403
SE50-42N	OV	4 2	567 x 116
SE50-43N	OV	4 3	567 x 173
SE50-44N	OV	4 4	567 x 231
SE50-45N	OV	4 5	567 x 288
SE50-46N	OV	4 6	567 x 346
SE50-47N	OV	4 7	567 x 403
SE50-52N	OV	5 2	700 x 116
SE50-53N	OV	5 3	700 x 173
SE50-54N	OV	5 4	700 x 231
SE50-55N	OV	5 5	700 x 288
SE50-56N	OV	5 6	700 x 346
SE50-57N	OV	5 7	700 x 403

With Hand Grip Closed Design



Please complete item number:

- B** Sides of the drawers approx. 10 mm high. Front with hand grip approx. 40 mm high. Examination of contents possible.
- F** Sides of the drawers approx. 20 mm high. Front with hand grip to max. height, closed. No examination of contents possible.

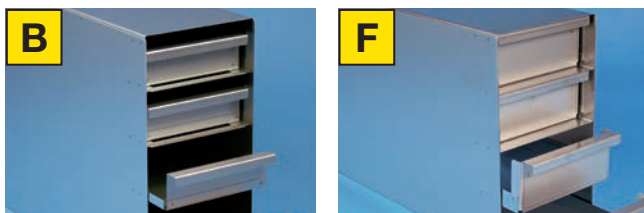

EPPi® 45 + 50 Drawer Racks • with Hand Grip

Useful for EPPi® 45 + 50 and all boxes up to external dimensions 133x133x53 mm (WxDxH). Base of drawers closed.

With Safety Stop			
Cat. No.	B	Number	DxH (mm)
	F		
SE50-22G	MV	2 2	301 x 123
SE50-23G	MV	2 3	301 x 184
SE50-24G	MV	2 4	301 x 245
SE50-25G	MV	2 5	301 x 306
SE50-26G	MV	2 6	301 x 367
SE50-27G	MV	2 7	301 x 428
SE50-32G	MV	3 2	434 x 123
SE50-33G	MV	3 3	434 x 184
SE50-34G	MV	3 4	434 x 245
SE50-35G	MV	3 5	434 x 306
SE50-36G	MV	3 6	434 x 367
SE50-37G	MV	3 7	434 x 428
SE50-42G	MV	4 2	567 x 123
SE50-43G	MV	4 3	567 x 184
SE50-44G	MV	4 4	567 x 245
SE50-45G	MV	4 5	567 x 306
SE50-46G	MV	4 6	567 x 367
SE50-47G	MV	4 7	567 x 428
SE50-52G	MV	5 2	700 x 123
SE50-53G	MV	5 3	700 x 184
SE50-54G	MV	5 4	700 x 245
SE50-55G	MV	5 5	700 x 306
SE50-56G	MV	5 6	700 x 367
SE50-57G	MV	5 7	700 x 428

Without Safety Stop			
Cat. No.	B	Number	DxH (mm)
	F		
SE50-22G	OV	2 2	301 x 116
SE50-23G	OV	2 3	301 x 173
SE50-24G	OV	2 4	301 x 231
SE50-25G	OV	2 5	301 x 288
SE50-26G	OV	2 6	301 x 346
SE50-27G	OV	2 7	301 x 403
SE50-32G	OV	3 2	434 x 116
SE50-33G	OV	3 3	434 x 173
SE50-34G	OV	3 4	434 x 231
SE50-35G	OV	3 5	434 x 288
SE50-36G	OV	3 6	434 x 346
SE50-37G	OV	3 7	434 x 403
SE50-42G	OV	4 2	567 x 116
SE50-43G	OV	4 3	567 x 173
SE50-44G	OV	4 4	567 x 231
SE50-45G	OV	4 5	567 x 288
SE50-46G	OV	4 6	567 x 346
SE50-47G	OV	4 7	567 x 403
SE50-52G	OV	5 2	700 x 116
SE50-53G	OV	5 3	700 x 173
SE50-54G	OV	5 4	700 x 231
SE50-55G	OV	5 5	700 x 288
SE50-56G	OV	5 6	700 x 346
SE50-57G	OV	5 7	700 x 403

EPPi® 32 Drawer Racks

With Hand Grip
Open Design 1)

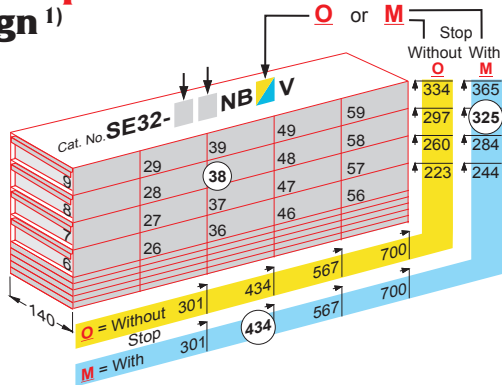

Example: Cat. No. SE32-38NBMV
For 24 boxes up to a height of 32 mm (e.g. EPPi 32).
With safety stop. Base of drawers closed.
Dimensions: WxDxH = 140x434x325 mm

EPPi® 37 Drawer Racks

With Hand Grip
Open Design 1)

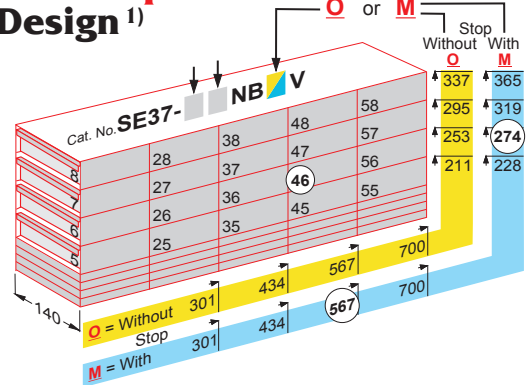

Example: Cat. No. SE37-46NBMV
For 24 boxes up to a height of 37 mm (e.g. EPPi 37).
With safety stop. Base of drawers closed.
Dimensions: WxDxH = 140x567x274 mm

EPPi® 70 + 75 Drawer Racks

With Folding Handle
Open Design 1)

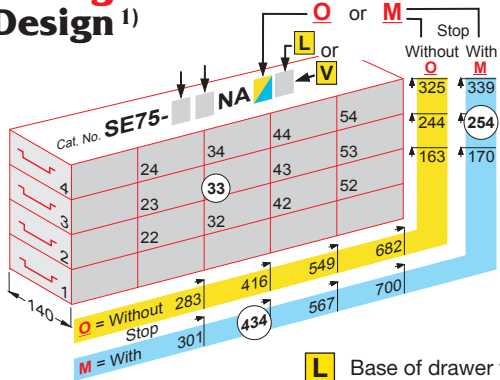

Example: Cat. No. SE75-33NAML
For 9 boxes up to a height of 76 mm (e.g. EPPi 75).
With safety stop. Base of drawers open.
Dimensions: WxDxH = 140x434x254 mm

L Base of drawer with center opening. Facilitates removal and insertion.
V Base of drawer closed. See illustrations on page 42

EPPi® 70 + 75 Drawer Racks

With Hand Grip
Version B 3)
Open Design 1)

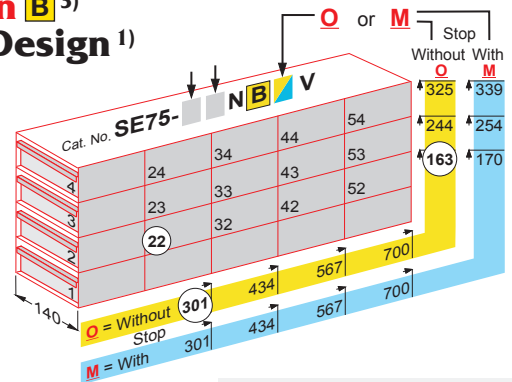

Example: Cat. No. SE75-22NB^BOV
For 4 boxes up to a height of 76 mm (e.g. EPPi 75).
Without safety stop. Base of drawers closed.
Dimensions: WxDxH = 140x301x163 mm

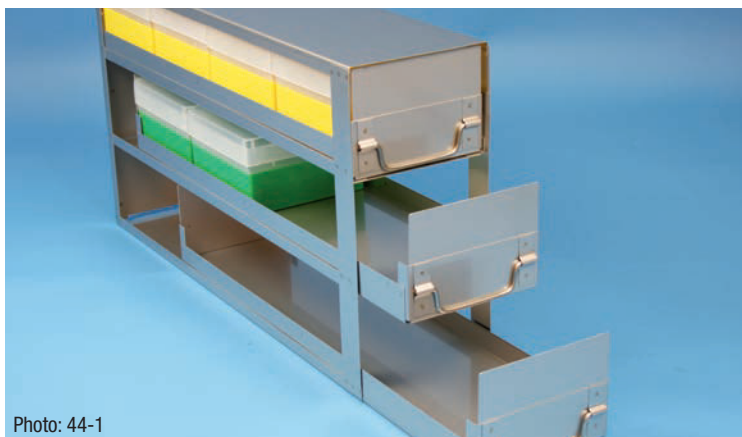

Photo: 44-1



Photo: 44-2



- All drawer racks can also be supplied with a closed design (See illustrations on page 42–43). Please enquire if needed.
- All drawer racks can be produced as a combo drawer rack for shallower boxes (e.g. EPPi 50) to exploit the interior space of uprights to the maximum.
- The drawer inserts can also be supplied in a modified design »F«. See page 43 for an explanation of the differences.

EPPi® 80 Drawer Racks

With Folding Handle Open Design 1)

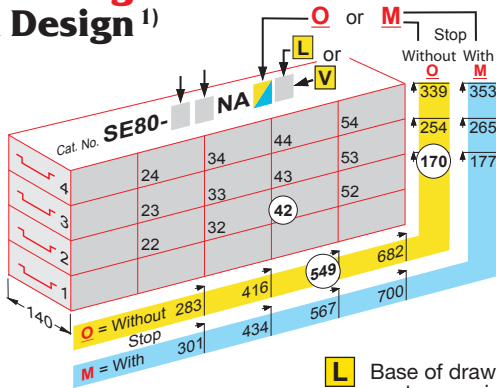

Example: Cat. No. SE80-42NAOL
For 8 boxes up to a height of 80 mm (e.g. EPPi 80).
Without safety stop. Base of drawers open.
Dimensions: WxDxH = 140x549x170 mm

- L** Base of drawer with center opening. Facilitates removal and insertion.
- V** Base of drawer closed. See illustrations on page 42

EPPi® 80 Drawer Racks

With Hand Grip Version B 3) Open Design 1)

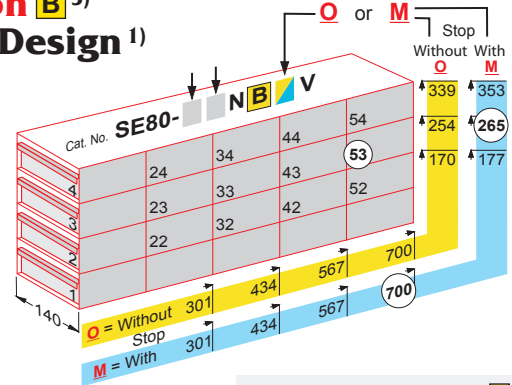

Example: Cat. No. SE80-53NBMV
For 15 boxes up to a height of 80 mm (e.g. EPPi 80).
With safety stop. Base of drawers closed.
Dimensions: WxDxH = 140x700x265 mm

EPPi® 95 + 96 Drawer Racks

With Folding Handle Open Design 1)

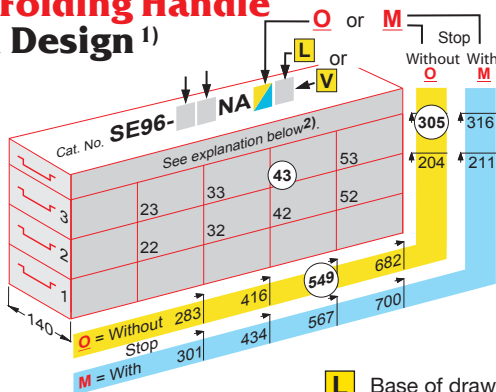

Example: Cat. No. SE96-43NAOL
For 12 boxes up to a height of 97 mm (e.g. EPPi 96).
Without safety stop. Base of drawers open.
Dimensions: WxDxH = 140x549x305 mm

- L** Base of drawer with center opening. Facilitates removal and insertion.
- V** Base of drawer closed. See illustrations on page 42

EPPi® 95 + 96 Drawer Racks

With Hand Grip Version B 3) Open Design 1)

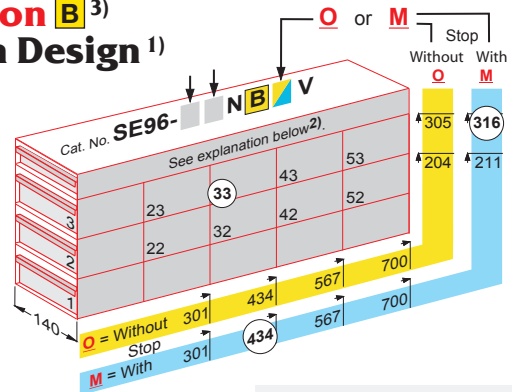

Example: Cat. No. SE96-33NBMV
For 9 boxes up to a height of 97 mm (e.g. EPPi 96).
With safety stop. Base of drawers closed.
Dimensions: WxDxH = 140x434x316 mm

EPPi® 102 Drawer Racks

With Folding Handle Open Design 1)

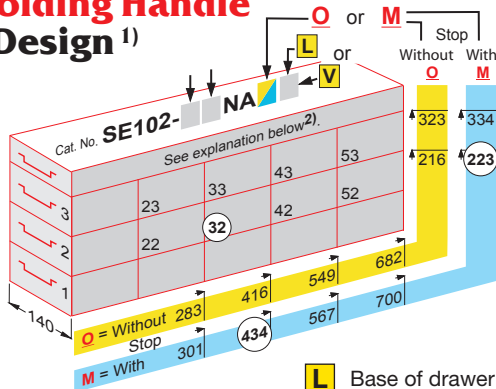

Example: Cat. No. SE102-32NAML
For 6 boxes up to a height of 103 mm (e.g. EPPi 102).
With safety stop. Base of drawers open.
Dimensions: WxDxH = 140x434x223 mm

- L** Base of drawer with center opening. Facilitates removal and insertion.
- V** Base of drawer closed. See illustrations on page 42

EPPi® 102 Drawer Racks

With Hand Grip Version B 3) Open Design 1)

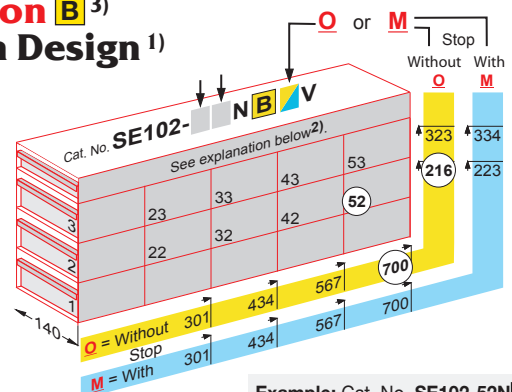

Example: Cat. No. SE102-52NBV
For 10 boxes up to a height of 103 mm (e.g. EPPi 102).
Without safety stop. Base of drawers closed.
Dimensions: WxDxH = 140x700x216 mm

Footnotes 1) and 2) and 3) see page 44.

EPPi® 105 Drawer Racks

With Folding Handle Open Design 1)

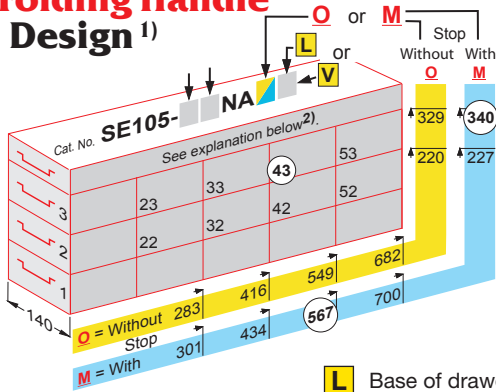

Example: Cat. No. SE105-43NAML
For 12 boxes up to a height of 105 mm (e.g. EPPi 105).
With safety stop. Base of drawers open.
Dimensions: WxDxH = 140x567x340 mm

- L** Base of drawer with center opening. Facilitates removal and insertion.
- V** Base of drawer closed. See illustrations on page 42

EPPi® 105 Drawer Racks

With Hand Grip Version B 3) Open Design 1)

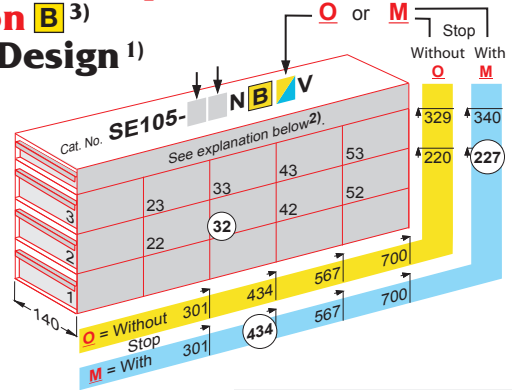

Example: Cat. No. SE105-32NBMV
For 6 boxes up to a height of 105 mm (z. B. EPPi 105).
With safety stop. Base of drawers closed.
Dimensions: WxDxH = 140x434x227 mm

EPPi® 128 Drawer Racks

With Folding Handle Open Design 1)

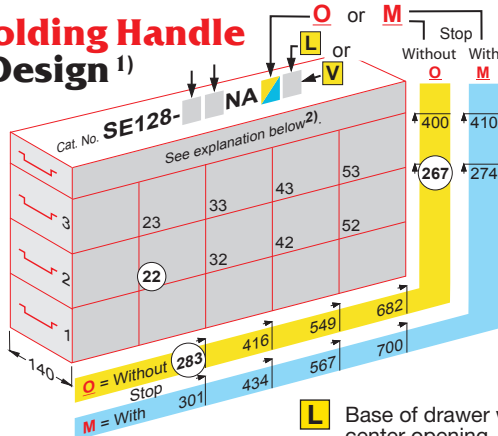

Example: Cat. No. SE128-22NAOL
For 4 boxes up to a height of 128 mm (e.g. EPPi 128).
Without safety stop. Base of drawers open.
Dimensions: WxDxH = 140x283x267 mm

- L** Base of drawer with center opening. Facilitates removal and insertion.
- V** Base of drawer closed. See illustrations on page 42

EPPi® 128 Drawer Racks

With Hand Grip Version B 3) Open Design 1)

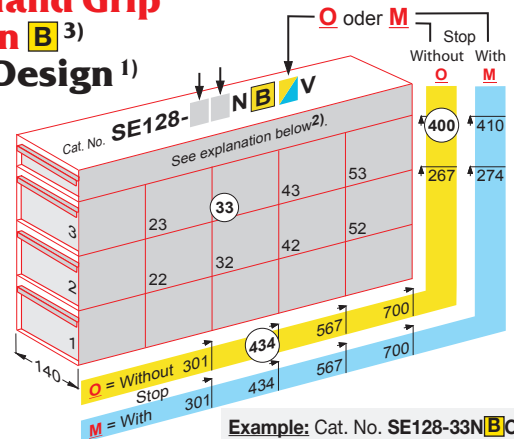

Example: Cat. No. SE128-33NBV
For 9 boxes up to a height of 128 mm (e.g. EPPi 128).
Without safety stop. Base of drawers closed.
Dimensions: WxDxH = 140x434x400 mm

EPPi® 133 Drawer Racks

With Folding Handle Open Design 1)

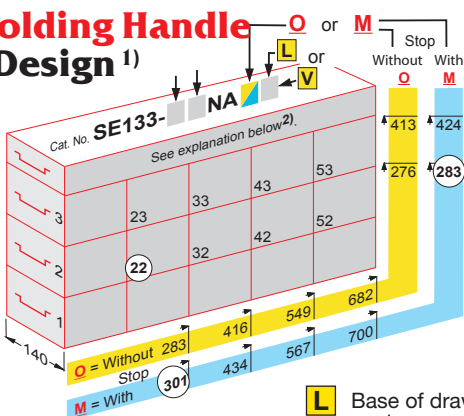

Example: Cat. No. SE133-22NAML
For 4 boxes up to a height of 133 mm (e.g. BRAVO 130).
With safety stop. Base of drawers open.
Dimensions: WxDxH = 140x301x283 mm

- L** Base of drawer with center opening. Facilitates removal and insertion.
- V** Base of drawer closed. See illustrations on page 42

EPPi® 133 Drawer Racks

With Hand Grip Version B 3) Open Design 1)

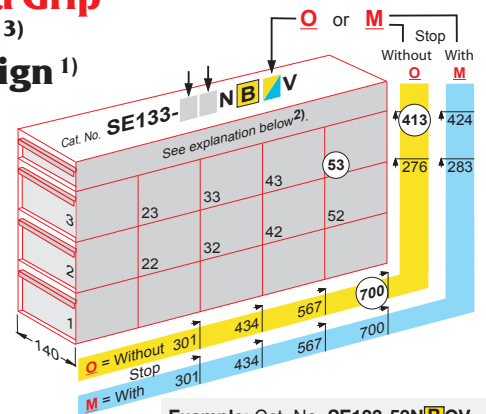

Example: Cat. No. SE133-53NBV
For 15 boxes up to a height of 133 mm (e.g. BRAVO 130).
Without safety stop. Base of drawers closed.
Dimensions: WxDxH = 140x700x413 mm

Footnotes 1) and 2) and 3) see page 44.



EPPi® Upright Bins

Single Width

With same external dimensions as horizontal racks. Open at top. With hand grip. Ideal for combining with horizontal racks and drawer racks.

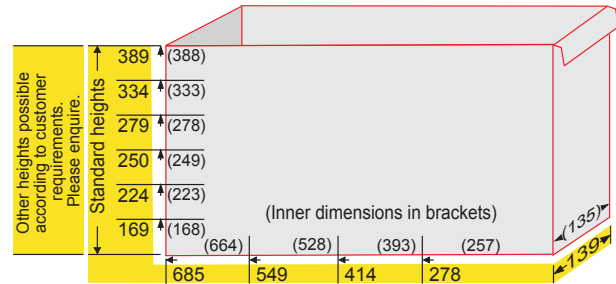

Standard Heights

Cat. No.	Number of Compartments	Inner Height mm	Ext. Dimensions WxDxH (mm)
SEK169-121BN	1	168	139x278x169
SEK169-131BN	1	168	139x414x169
SEK169-141BN	1	168	139x549x169
SEK169-151BN	1	168	139x685x169
SEK224-121BN	1	223	139x278x224
SEK224-131BN	1	223	139x414x224
SEK224-141BN	1	223	139x549x224
SEK224-151BN	1	223	139x685x224
SEK250-121BN	1	249	139x278x250
SEK250-131BN	1	249	139x414x250
SEK250-141BN	1	249	139x549x250
SEK250-151BN	1	249	139x685x250

Standard Heights

Cat. No.	Number of Compartments	Inner Height mm	Ext. Dimensions WxDxH (mm)
SEK279-121BN	1	278	139x278x279
SEK279-131BN	1	278	139x414x279
SEK279-141BN	1	278	139x549x279
SEK279-151BN	1	278	139x685x279
SEK334-121BN	1	333	139x278x334
SEK334-131BN	1	333	139x414x334
SEK334-141BN	1	333	139x549x334
SEK334-151BN	1	333	139x685x334
SEK389-121BN	1	388	139x278x389
SEK389-131BN	1	388	139x414x389
SEK389-141BN	1	388	139x549x389
SEK389-151BN	1	388	139x685x389

EPPi® Upright Bins

Double Width

With same external dimensions as horizontal racks. Open at top. With hand grip. Ideal for combining with horizontal racks and drawer racks.

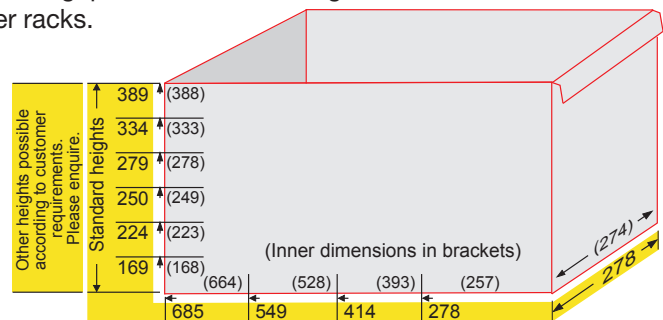

Standard Heights

Cat. No.	Number of Compartments	Inner Height mm	Ext. Dimensions WxDxH (mm)
SEK169-221BN	1	168	278x278x169
SEK169-231BN	1	168	278x414x169
SEK169-241BN	1	168	278x549x169
SEK169-251BN	1	168	278x685x169
SEK224-221BN	1	223	278x278x224
SEK224-231BN	1	223	278x414x224
SEK224-241BN	1	223	278x549x224
SEK224-251BN	1	223	278x685x224
SEK250-221BN	1	249	278x278x250
SEK250-231BN	1	249	278x414x250
SEK250-241BN	1	249	278x549x250
SEK250-251BN	1	249	278x685x250

Standard Heights

Cat. No.	Number of Compartments	Inner Height mm	Ext. Dimensions WxDxH (mm)
SEK279-221BN	1	278	278x278x279
SEK279-231BN	1	278	278x414x279
SEK279-241BN	1	278	278x549x279
SEK279-251BN	1	278	278x685x279
SEK334-221BN	1	333	278x278x334
SEK334-231BN	1	333	278x414x334
SEK334-241BN	1	333	278x549x334
SEK334-251BN	1	333	278x685x334
SEK389-221BN	1	388	278x278x389
SEK389-231BN	1	388	278x414x389
SEK389-241BN	1	388	278x549x389
SEK389-251BN	1	388	278x685x389

Special designs on request. See also ALPHA upright bins page 53.

ALPHA Box made of Fiberboard

136 x 136 mm • Cryo and Storage Boxes

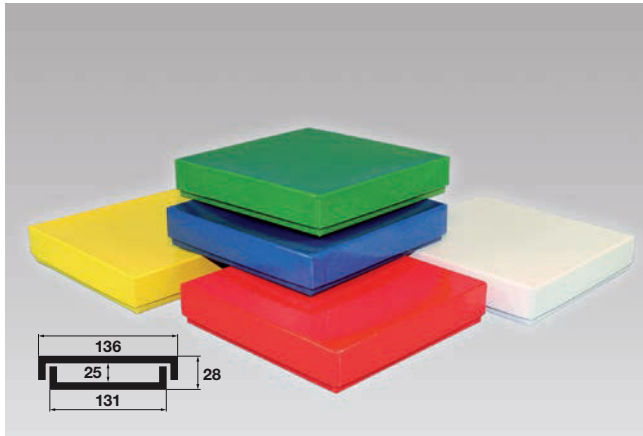

ALPHA Box 136x136 • height 25 mm

Standard box design made of water-repellent fiberboard suitable for ultra-low temperatures. Quality »special« with additional plastic water-proof coating. With lid. Height = inner height. Other colours and dimensions can be produced on request.

Standard

Cat. No.	Colour
KA1025WH1	white
KA1025BU1	blue
KA1025YE1	yellow
KA1025GR1	green
KA1025RE1	red
KA1025OR1	orange

Special

Cat. No.	Colour
KA1025WH2	white
KA1025BU2	blue
KA1025YE2	yellow
KA1025GR2	green
KA1025RE2	red
KA1025OR2	orange

Grid dividers can be ordered separately or can be supplied fitted (see page 49).

Matching Racks

Vertical Racks
page 50
Horizontal Racks
page 51–52
Drawer Racks
page 56
Upright Bins
page 53

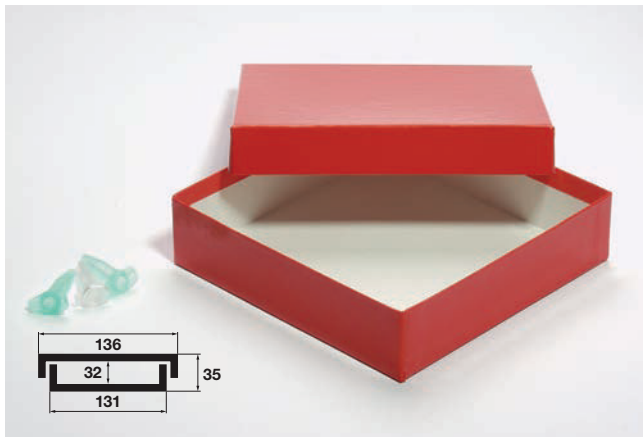

ALPHA Box 136x136 • height 32 mm

Standard box design made of water-repellent fiberboard suitable for ultra-low temperatures. Quality »special« with additional plastic water-proof coating. With lid. Height = inner height. Other colours and dimensions can be produced on request.

Standard

Cat. No.	Colour
KA1032WH1	white
KA1032BU1	blue
KA1032YE1	yellow
KA1032GR1	green
KA1032RE1	red
KA1032OR1	orange

Special

Cat. No.	Colour
KA1032WH2	white
KA1032BU2	blue
KA1032YE2	yellow
KA1032GR2	green
KA1032RE2	red
KA1032OR2	orange

Grid dividers can be ordered separately or can be supplied fitted (see page 49).

Matching Racks

Vertical Racks
page 50
Horizontal Racks
page 51–52
Drawer Racks
page 56
Upright Bins
page 53



ALPHA Box 136x136 • height 50 mm

Standard box design made of water-repellent fiberboard suitable for ultra-low temperatures. Quality »special« with additional plastic water-proof coating. With lid. Height = inner height. Other colours and dimensions can be produced on request.

Standard

Cat. No.	Colour
KA1050WH1	white
KA1050BU1	blue
KA1050YE1	yellow
KA1050GR1	green
KA1050RE1	red
KA1050OR1	orange

Special

Cat. No.	Colour
KA1050WH2	white
KA1050BU2	blue
KA1050YE2	yellow
KA1050GR2	green
KA1050RE2	red
KA1050OR2	orange

Grid dividers can be ordered separately or can be supplied fitted (see page 49).

Matching Racks

Vertical Racks
page 50
Horizontal Racks
page 51–52
Drawer Racks
page 54–55
Upright Bins
page 53

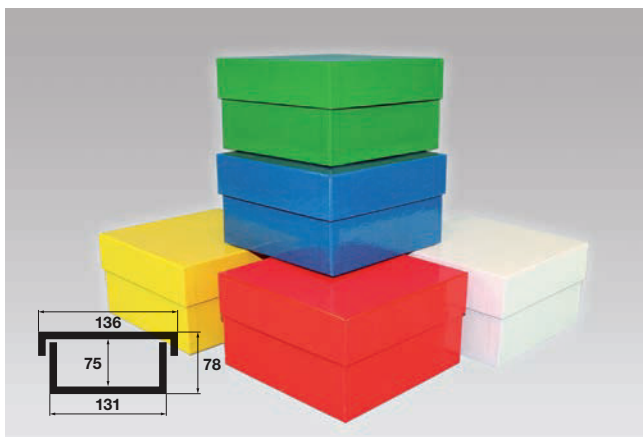

ALPHA Box 136x136 • height 75 mm

Standard box design made of water-repellent fiberboard suitable for ultra-low temperatures. Quality »special« with additional plastic water-proof coating. With lid. Height = inner height. Other colours and dimensions can be produced on request.

Standard

Cat. No.	Colour
KA1075WH1	white
KA1075BU1	blue
KA1075YE1	yellow
KA1075GR1	green
KA1075RE1	red
KA1075OR1	orange

Special

Cat. No.	Colour
KA1075WH2	white
KA1075BU2	blue
KA1075YE2	yellow
KA1075GR2	green
KA1075RE2	red
KA1075OR2	orange

Grid dividers can be ordered separately or can be supplied fitted (see page 49).

Matching Racks

Vertical Racks
page 50
Horizontal Racks
page 51–52
Drawer Racks
page 57
Upright Bins
page 53

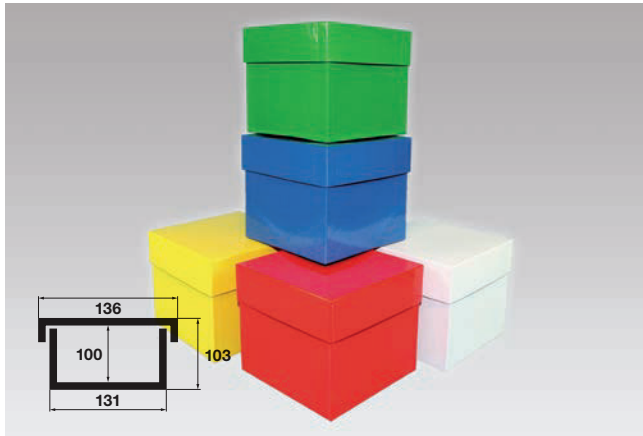

ALPHA Box 136x136 • height 100 mm

Standard box design made of water-repellent fiberboard suitable for ultra-low temperatures. Quality »special« with additional plastic water-proof coating. With lid. Height = inner height. Other colours and dimensions can be produced on request.

Standard		Special	
Cat. No.	Colour	Cat. No.	Colour
KA1100WH1	white	KA1100WH2	white
KA1100BU1	blue	KA1100BU2	blue
KA1100YE1	yellow	KA1100YE2	yellow
KA1100GR1	green	KA1100GR2	green
KA1100RE1	red	KA1100RE2	red
KA1100OR1	orange	KA1100OR2	orange

Grid dividers can be ordered separately or can be supplied fitted (see below).

Matching Racks

Vertical Racks
page 50

Horizontal Racks
page 51–52

Drawer Racks
page 57

Upright Bins
page 53

Please enquire for ALPHA Box with height of 110 mm.

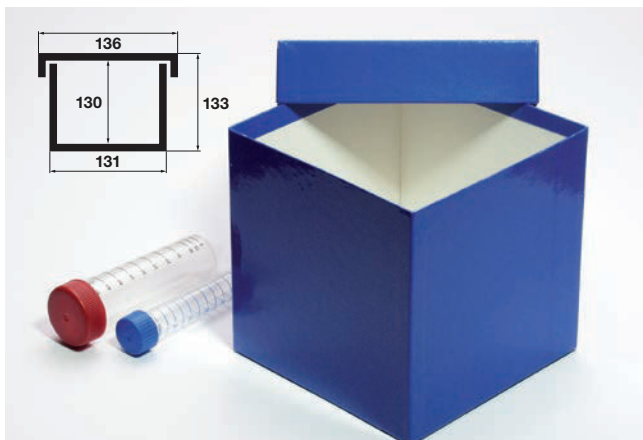

ALPHA Box 136x136 • height 130 mm

Standard box design made of water-repellent fiberboard suitable for ultra-low temperatures. Quality »special« with additional plastic water-proof coating. With lid. Height = inner height. Other colours and dimensions can be produced on request.

Standard		Special	
Cat. No.	Colour	Cat. No.	Colour
KA1130WH1	white	KA1130WH2	white
KA1130BU1	blue	KA1130BU2	blue
KA1130YE1	yellow	KA1130YE2	yellow
KA1130GR1	green	KA1130GR2	green
KA1130RE1	red	KA1130RE2	red
KA1130OR1	orange	KA1130OR2	orange

Grid dividers can be ordered separately or can be supplied fitted (see below).

Matching Racks

Vertical Racks
page 50

Horizontal Racks
page 51–52

Drawer Racks
page 57

Upright Bins
page 53

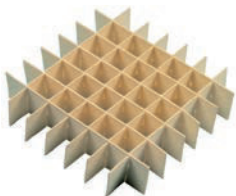

Grid Dividers made of Fiberboard

for ALPHA Box and all boxes up to 136 x 136 mm

Matching grid dividers made of Polypropylene (PP) see EPPi MAX on page 3.

Cells for Tubes	Heights					
	15 mm	25 mm	30 mm	40 mm	65 mm	80 mm
	Cat. No.	Cat. No.	Cat. No.	Cat. No.	Cat. No.	Cat. No.
16x16 up to ca. 7.5 mm Ø	RA10151616N	RA10251616N	RA10301616N	RA10401616N	RA10651616N	RA10801616N
15x15 up to ca. 8.0 mm Ø	RA10151515N	RA10251515N	RA10301515N	RA10401515N	RA10651515N	RA10801515N
14x14 up to ca. 8.7 mm Ø	RA10151414N	RA10251414N	RA10301414N	RA10401414N	RA10651414N	RA10801414N
13x13 up to ca. 9.4 mm Ø	RA10151313N	RA10251313N	RA10301313N	RA10401313N	RA10651313N	RA10801313N
12x12 up to ca. 10.2 mm Ø	RA10151212N	RA10251212N	RA10301212N	RA10401212N	RA10651212N	RA10801212N
11x11 up to ca. 11.2 mm Ø	RA10151111N	RA10251111N	RA10301111N	RA10401111N	RA10651111N	RA10801111N
10x10 up to ca. 12.5 mm Ø	RA10151010N	RA10251010N	RA10301010N	RA10401010N	RA10651010N	RA10801010N
9x9 up to ca. 13.9 mm Ø	RA10150909N	RA10250909N	RA10300909N	RA10400909N	RA10650909N	RA10800909N
8x8 up to ca. 15.7 mm Ø	RA10150808N	RA10250808N	RA10300808N	RA10400808N	RA10650808N	RA10800808N
7x7 up to ca. 17.9 mm Ø	RA10150707N	RA10250707N	RA10300707N	RA10400707N	RA10650707N	RA10800707N
6x6 up to ca. 21.0 mm Ø	RA10150606N	RA10250606N	RA10300606N	RA10400606N	RA10650606N	RA10800606N
5x5 up to ca. 25.5 mm Ø	RA10150505N	RA10250505N	RA10300505N	RA10400505N	RA10650505N	RA10800505N
4x4 up to ca. 32.0 mm Ø	RA10150404N	RA10250404N	RA10300404N	RA10400404N	RA10650404N	RA10800404N
3x3 up to ca. 42.9 mm Ø	RA10150303N	RA10250303N	RA10300303N	RA10400303N	RA10650303N	RA10800303N

When used with item number given in the overview (beginning with "RA1..."), grid dividers are always supplied separately (standard supply).

Instead of the customary method of supplying the box and grid divider separately, the box can be supplied with the grid divider already inserted. For this purpose the code in the item number for the grid divider (highlighted in yellow) must be added to the item number of the box.

Example: ALPHA Box of height 50 mm, white, standard as well as inserted grid divider of height 30 mm with 10x10 cells.

KA1050WH1 + 0301010N = Cat. No. KA1050WH10301010N



ALPHA 25 Vertical Racks

Useful for ALPHA 25 and all boxes up to external dimensions 136x136x28 mm (WxDxH).
2 boxes in each bay,
total number in ().

Cat. No.	Bays	Height (mm)
TA25-08AN2	4 (8)	238
TA25-10AN2	5 (10)	296
TA25-12AN2	6 (12)	354
TA25-14AN2	7 (14)	412
TA25-16AN2	8 (16)	470
TA25-18AN2	9 (18)	528
TA25-20AN2	10 (20)	586
TA25-22AN2	11 (22)	644
TA25-24AN2	12 (24)	702
TA25-26AN2	13 (26)	760



ALPHA 32 Vertical Racks

Useful for ALPHA 32 and all boxes up to external dimensions 136x136x35 mm (WxDxH).
2 boxes in each bay,
total number in ().

Cat. No.	Bays	Height (mm)
TA32-06AN2	3 (6)	222
TA32-08AN2	4 (8)	294
TA32-10AN2	5 (10)	366
TA32-12AN2	6 (12)	438
TA32-14AN2	7 (14)	510
TA32-16AN2	8 (16)	582
TA32-18AN2	9 (18)	654
TA32-20AN2	10 (20)	726

ALPHA 50 Vertical Racks

Useful for ALPHA 50 and all boxes up to external dimensions 136x136x53 mm (WxDxH).

Cat. No.	Bays	Height (mm)
TA50-04AN	4	226
TA50-05AN	5	281
TA50-06AN	6	336
TA50-07AN	7	391
TA50-08AN	8	446
TA50-09AN	9	501
TA50-10AN	10	556
TA50-11AN	11	611
TA50-12AN	12	666
TA50-13AN	13	721
TA50-14AN	14	776



ALPHA 75 Vertical Racks

Useful for ALPHA 75 and all boxes up to external dimensions 136x136x78 mm (WxDxH).

Cat. No.	Bays	Height (mm)
TA75-03AN	3	246
TA75-04AN	4	326
TA75-05AN	5	406
TA75-06AN	6	486
TA75-07AN	7	566
TA75-08AN	8	646
TA75-09AN	9	726

ALPHA 100 Vertical Racks

Useful for ALPHA 100 and all boxes up to external dimensions 136x136x103 mm (WxDxH).

Cat. No.	Bays	Height (mm)
TA100-03AN	3	321
TA100-04AN	4	426
TA100-05AN	5	531
TA100-06AN	6	636
TA100-07AN	7	741

ALPHA 110 Vertical Racks

Useful for ALPHA 110 and all boxes up to external dimensions 136x136x113 mm (WxDxH).

Cat. No.	Bays	Height (mm)
TA110-03AN	3	351
TA110-04AN	4	466
TA110-05AN	5	581
TA110-06AN	6	696
TA110-07AN	7	811



ALPHA 130 Vertical Racks

Useful for ALPHA 130 and all boxes up to external dimensions 136x136x133 mm (WxDxH).

Cat. No.	Bays	Height (mm)
TA130-03AN	3	411
TA130-04AN	4	546
TA130-05AN	5	681



EPPi Ident Identification Tags see page 19.



Folding handle positioned crosswise as standard.

Alternatives: Folding handle positioned lengthwise or hand grip. Please enquire if needed.



All vertical racks can be supplied with a safety rod if required.

This increases the depth by 7 mm to 148 mm. Please enquire if needed.



ALPHA 25 Horizontal Racks

Useful for ALPHA 25 and all boxes up to external dimensions 136x136x28 mm (WxDxH).
2 boxes in each bay,
total number in ().

Cat. No.	Bays Depth x Height	Dimensions Dx H (mm)
SAE25-2x08AN2	2 x 4 (16)	286x236
SAE25-2x10AN2	2 x 5 (20)	286x294
SAE25-2x12AN2	2 x 6 (24)	286x352
SAE25-3x08AN2	3 x 4 (24)	426x236
SAE25-3x10AN2	3 x 5 (30)	426x294
SAE25-3x12AN2	3 x 6 (36)	426x352
SAE25-4x08AN2	4 x 4 (32)	565x236
SAE25-4x10AN2	4 x 5 (40)	565x294
SAE25-4x12AN2	4 x 6 (48)	565x352
SAE25-5x08AN2	5 x 4 (40)	705x236
SAE25-5x10AN2	5 x 5 (50)	705x294
SAE25-5x12AN2	5 x 6 (60)	705x352



ALPHA 32 Horizontal Racks

Useful for ALPHA 32 and all boxes up to external dimensions 136x136x35 mm (WxDxH).
2 boxes in each bay,
total number in ().

Cat. No.	Bays Depth x Height	Dimensions Dx H (mm)
SAE32-36AN2	3x3 (18)	426x220
SAE32-38AN2	3x4 (24)	426x292
SAE32-46AN2	4x3 (24)	565x220
SAE32-48AN2	4x4 (32)	565x292
SAE32-56AN2	5x3 (30)	705x220
SAE32-58AN2	5x4 (40)	705x292

ALPHA 50 Horizontal Racks

Useful for ALPHA 50 and all boxes up to external dimensions 136x136x53 mm (WxDxH).

Cat. No.	Bays Depth x Height	Dimensions Dx H (mm)
SAE50-24AN	2 x 4	286x224
SAE50-25AN	2 x 5	286x279
SAE50-26AN	2 x 6	286x334
SAE50-33AN	3 x 3	426x169
SAE50-34AN	3 x 4	426x224
SAE50-35AN	3 x 5	426x279
SAE50-36AN	3 x 6	426x334
SAE50-37AN	3 x 7	426x389
SAE50-43AN	4 x 3	565x169
SAE50-44AN	4 x 4	565x224
SAE50-45AN	4 x 5	565x279
SAE50-46AN	4 x 6	565x334
SAE50-47AN	4 x 7	565x389
SAE50-53AN	5 x 3	705x169
SAE50-54AN	5 x 4	705x224
SAE50-55AN	5 x 5	705x279
SAE50-56AN	5 x 6	705x334
SAE50-57AN	5 x 7	705x389



Folding handle positioned vertically as standard.
Alternatives: Folding handle positioned horizontally or hand grip. Please enquire if needed.

ALPHA 75 Horizontal Racks

Useful for ALPHA 75 and all boxes up to external dimensions 136x136x78 mm (WxDxH).

Cat. No.	Bays Depth x Height	Dimensions Dx H (mm)
SAE75-32AN	3 x 2	426x164
SAE75-33AN	3 x 3	426x244
SAE75-34AN	3 x 4	426x324
SAE75-42AN	4 x 2	565x164
SAE75-43AN	4 x 3	565x244
SAE75-44AN	4 x 4	565x324
SAE75-52AN	5 x 2	705x164
SAE75-53AN	5 x 3	705x244
SAE75-54AN	5 x 4	705x324



ALPHA 100 Horizontal Racks

Useful for ALPHA 100 and all boxes up to external dimensions 136x136x103 mm (WxDxH).

Cat. No.	Bays Depth x Height	Dimensions Dx H (mm)
SAE100-32AN	3 x 2	426x214
SAE100-33AN	3 x 3	426x319
SAE100-42AN	4 x 2	565x214
SAE100-43AN	4 x 3	565x319
SAE100-52AN	5 x 2	705x214
SAE100-53AN	5 x 3	705x319

ALPHA 110 Horizontal Racks

Useful for ALPHA 110 and all boxes up to external dimensions 136x136x113 mm (WxDxH).

Cat. No.	Bays Depth x Height	Dimensions Dx H (mm)
SAE110-32AN	3 x 2	426x234
SAE110-33AN	3 x 3	426x349
SAE110-42AN	4 x 2	565x234
SAE110-43AN	4 x 3	565x349
SAE110-52AN	5 x 2	705x234
SAE110-53AN	5 x 3	705x349



All horizontal racks can be supplied with safety rods if required. Add 7 mm to width and 3 mm to height. Please enquire if needed.

ALPHA 130 Horizontal Racks

Useful for ALPHA 130 and all boxes up to external dimensions 136x136x133 mm (WxDxH).

Cat. No.	Bays Depth x Height	Dimensions Dx H (mm)
SAE130-32AN	3 x 2	426x279
SAE130-33AN	3 x 3	426x409
SAE130-42AN	4 x 2	565x279
SAE130-43AN	4 x 3	565x409
SAE130-52AN	5 x 2	705x279
SAE130-53AN	5 x 3	705x409



Photo: 51-1



Photo: 51-2

ALPHA Horizontal Racks

Width 140 mm • Stainless steel



ALPHA Horizontal Racks without intermediate shelf

For ALPHA boxes of different heights. Also useful for boxes with external dimensions of up to 136 x 136 mm (WxD).

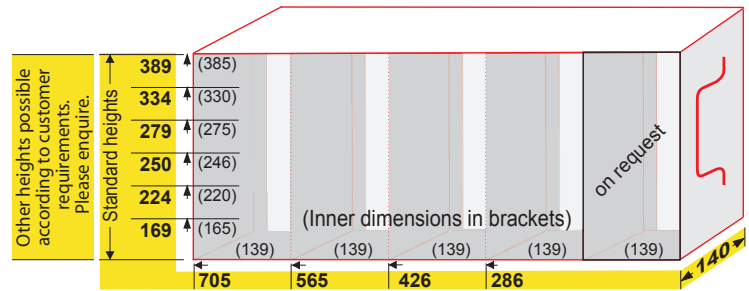

Standard Heights

Cat. No.	Bays Depth x Height	Inner Height Bay (mm)	Dimensions D x H (mm)
SAEX169-2-01AN	2 x 1	165	286x169
SAEX169-3-01AN	3 x 1	165	426x169
SAEX169-4-01AN	4 x 1	165	565x169
SAEX169-5-01AN	5 x 1	165	705x169
SAEX224-2-01AN	2 x 1	220	286x224
SAEX224-3-01AN	3 x 1	220	426x224
SAEX224-4-01AN	4 x 1	220	565x224
SAEX224-5-01AN	5 x 1	220	705x224
SAEX250-2-01AN	2 x 1	246	286x250
SAEX250-3-01AN	3 x 1	246	426x250
SAEX250-4-01AN	4 x 1	246	565x250
SAEX250-5-01AN	5 x 1	246	705x250

Standard Heights

Cat. No.	Bays Depth x Height	Inner Height Bay (mm)	Dimensions D x H (mm)
SAEX279-2-01AN	2 x 1	275	286x279
SAEX279-3-01AN	3 x 1	275	426x279
SAEX279-4-01AN	4 x 1	275	565x279
SAEX279-5-01AN	5 x 1	275	705x279
SAEX334-2-01AN	2 x 1	330	286x334
SAEX334-3-01AN	3 x 1	330	426x334
SAEX334-4-01AN	4 x 1	330	565x334
SAEX334-5-01AN	5 x 1	330	705x334
SAEX389-2-01AN	2 x 1	385	286x389
SAEX389-3-01AN	3 x 1	385	426x389
SAEX389-4-01AN	4 x 1	385	565x389
SAEX389-5-01AN	5 x 1	385	705x389



ALPHA Horizontal Racks with one intermediate shelf

For ALPHA boxes of different heights. Also useful for boxes with external dimensions of up to 136 x 136 mm (WxD).

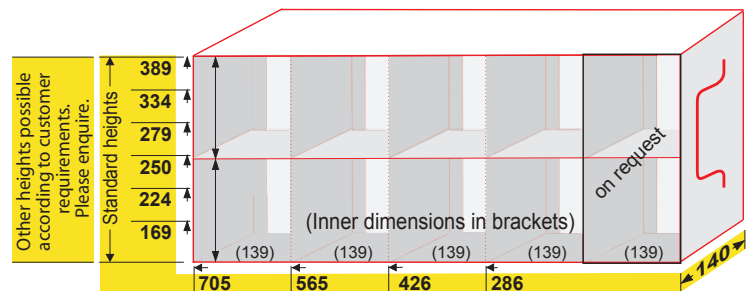

Standard Heights

Cat. No.	Bays Depth x Height	Inner Height Bay (mm)	Dimensions D x H (mm)
SAEX169-2-02AN	2x2	82	286x169
SAEX169-3-02AN	3x2	82	426x169
SAEX169-4-02AN	4x2	82	565x169
SAEX169-5-02AN	5x2	82	705x169
SAEX224-2-02AN	2x2	109	286x224
SAEX224-3-02AN	3x2	109	426x224
SAEX224-4-02AN	4x2	109	565x224
SAEX224-5-02AN	5x2	109	705x224
SAEX250-2-02AN	2x2	122	286x250
SAEX250-3-02AN	3x2	122	426x250
SAEX250-4-02AN	4x2	122	565x250
SAEX250-5-02AN	5x2	122	705x250

Standard Heights

Cat. No.	Bays Depth x Height	Inner Height Bay (mm)	Dimensions D x H (mm)
SAEX279-2-02AN	2x2	137	286x279
SAEX279-3-02AN	3x2	137	426x279
SAEX279-4-02AN	4x2	137	565x279
SAEX279-5-02AN	5x2	137	705x279
SAEX334-2-02AN	2x2	164	286x334
SAEX334-3-02AN	3x2	164	426x334
SAEX334-4-02AN	4x2	164	565x334
SAEX334-5-02AN	5x2	164	705x334
SAEX389-2-02AN	2x2	192	286x389
SAEX389-3-02AN	3x2	192	426x389
SAEX389-4-02AN	4x2	192	565x389
SAEX389-5-02AN	5x2	192	705x389



Folding handle positioned vertically as standard.

Alternatives: Folding handle positioned horizontally or hand grip. Please enquire if needed.



All horizontal racks can be supplied with safety rods if required. Add 7 mm to width and 3 mm to height. Please enquire if needed.

ALPHA Upright Bins

Width 142 and 284 mm • Stainless steel



ALPHA Upright Bins

Single Width

With same external dimensions as horizontal racks. Open at top. With hand grip. Ideal for combining with horizontal racks and drawer racks.

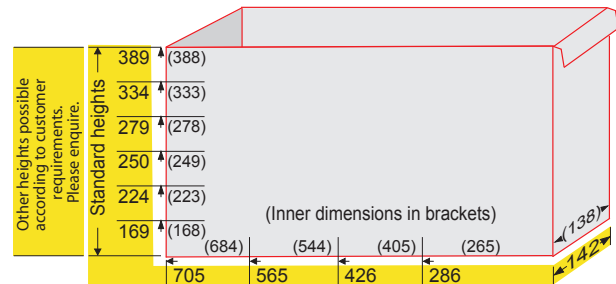

Standard Heights

Cat. No.	Number of Compartments	Inner Height mm	Ext. Dimensions WxDxH (mm)
SAK169-121BN	1	168	142x286x169
SAK169-131BN	1	168	142x426x169
SAK169-141BN	1	168	142x565x169
SAK169-151BN	1	168	142x705x169
SAK224-121BN	1	223	142x286x224
SAK224-131BN	1	223	142x426x224
SAK224-141BN	1	223	142x565x224
SAK224-151BN	1	223	142x705x224
SAK250-121BN	1	249	142x286x250
SAK250-131BN	1	249	142x426x250
SAK250-141BN	1	249	142x565x250
SAK250-151BN	1	249	142x705x250

Standard Heights

Cat. No.	Number of Compartments	Inner Height mm	Ext. Dimensions WxDxH (mm)
SAK279-121BN	1	278	142x286x279
SAK279-131BN	1	278	142x426x279
SAK279-141BN	1	278	142x565x279
SAK279-151BN	1	278	142x705x279
SAK334-121BN	1	333	142x286x334
SAK334-131BN	1	333	142x426x334
SAK334-141BN	1	333	142x565x334
SAK334-151BN	1	333	142x705x334
SAK389-121BN	1	388	142x286x389
SAK389-131BN	1	388	142x426x389
SAK389-141BN	1	388	142x565x389
SAK389-151BN	1	388	142x705x389

ALPHA Upright Bins

Double Width

With same external dimensions as horizontal racks. Open at top. With hand grip. Ideal for combining with horizontal racks and drawer racks.

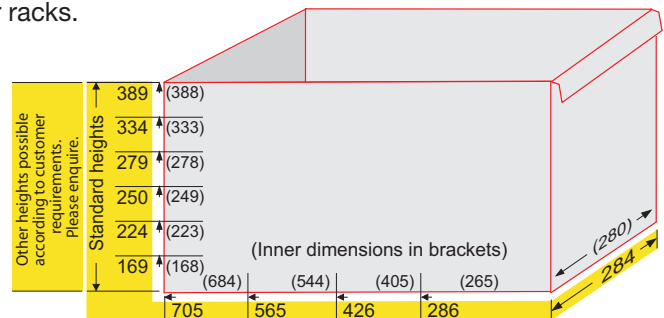

Standard Heights

Cat. No.	Number of Compartments	Inner Height mm	Ext. Dimensions WxDxH (mm)
SAK169-221BN	1	168	284x286x169
SAK169-231BN	1	168	284x426x169
SAK169-241BN	1	168	284x565x169
SAK169-251BN	1	168	284x705x169
SAK224-221BN	1	223	284x286x224
SAK224-231BN	1	223	284x426x224
SAK224-241BN	1	223	284x565x224
SAK224-251BN	1	223	284x705x224
SAK250-221BN	1	249	284x286x250
SAK250-231BN	1	249	284x426x250
SAK250-241BN	1	249	284x565x250
SAK250-251BN	1	249	284x705x250

Standard Heights

Cat. No.	Number of Compartments	Inner Height mm	Ext. Dimensions WxDxH (mm)
SAK279-221BN	1	278	284x286x279
SAK279-231BN	1	278	284x426x279
SAK279-241BN	1	278	284x565x279
SAK279-251BN	1	278	284x705x279
SAK334-221BN	1	333	284x286x334
SAK334-231BN	1	333	284x426x334
SAK334-241BN	1	333	284x565x334
SAK334-251BN	1	333	284x705x334
SAK389-221BN	1	388	284x286x389
SAK389-231BN	1	388	284x426x389
SAK389-241BN	1	388	284x565x389
SAK389-251BN	1	388	284x705x389

Special designs on request. See also EPPi upright bins page 47.

With Folding Handle Open Design

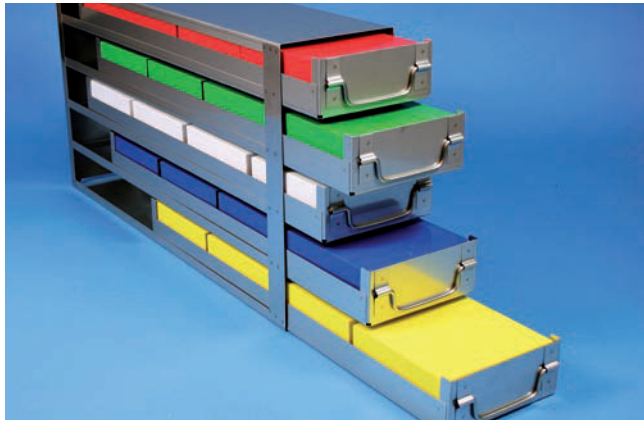

Please complete item number:

L Base of drawer with center opening.
Facilitates removal and insertion.

V Base of drawer closed.

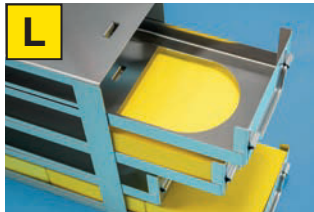

With Folding Handle Closed Design

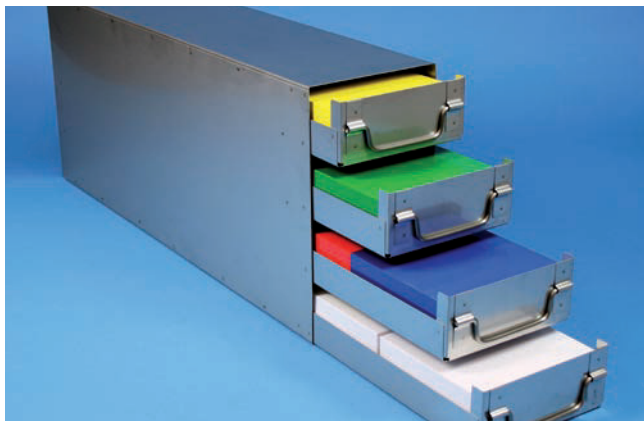

Please complete item number:

L Base of drawer with center opening.
Facilitates removal and insertion.

V Base of drawer closed.



ALPHA 50 Drawer Racks • with Folding Handle

Useful for ALPHA 50 and all boxes up to external dimensions 136x136x53 mm (WxDxH). Front closed.

With Safety Stop			
Cat. No.	L	Number	DxH
	V	Depth	Height (mm)
SAE50-22NAM	■	2	2 308 x 123
SAE50-23NAM	■	2	3 308 x 184
SAE50-24NAM	■	2	4 308 x 245
SAE50-25NAM	■	2	5 308 x 306
SAE50-26NAM	■	2	6 308 x 367
SAE50-27NAM	■	2	7 308 x 428
SAE50-32NAM	■	3	2 439 x 123
SAE50-33NAM	■	3	3 439 x 184
SAE50-34NAM	■	3	4 439 x 245
SAE50-35NAM	■	3	5 439 x 306
SAE50-36NAM	■	3	6 439 x 367
SAE50-37NAM	■	3	7 439 x 428
SAE50-42NAM	■	4	2 569 x 123
SAE50-43NAM	■	4	3 569 x 184
SAE50-44NAM	■	4	4 569 x 245
SAE50-45NAM	■	4	5 569 x 306
SAE50-46NAM	■	4	6 569 x 367
SAE50-47NAM	■	4	7 569 x 428
SAE50-52NAM	■	5	2 710 x 123
SAE50-53NAM	■	5	3 710 x 184
SAE50-54NAM	■	5	4 710 x 245
SAE50-55NAM	■	5	5 710 x 306
SAE50-56NAM	■	5	6 710 x 367
SAE50-57NAM	■	5	7 710 x 428

Without Safety Stop			
Cat. No.	L	Number	DxH
	V	Depth	Height (mm)
SAE50-22NAO	■	2	2 293 x 113
SAE50-23NAO	■	2	3 293 x 169
SAE50-24NAO	■	2	4 293 x 225
SAE50-25NAO	■	2	5 293 x 281
SAE50-26NAO	■	2	6 293 x 337
SAE50-27NAO	■	2	7 293 x 393
SAE50-32NAO	■	3	2 429 x 113
SAE50-33NAO	■	3	3 429 x 169
SAE50-34NAO	■	3	4 429 x 225
SAE50-35NAO	■	3	5 429 x 281
SAE50-36NAO	■	3	6 429 x 337
SAE50-37NAO	■	3	7 429 x 393
SAE50-42NAO	■	4	2 565 x 113
SAE50-43NAO	■	4	3 565 x 169
SAE50-44NAO	■	4	4 565 x 225
SAE50-45NAO	■	4	5 565 x 281
SAE50-46NAO	■	4	6 565 x 337
SAE50-47NAO	■	4	7 565 x 393
SAE50-52NAO	■	5	2 701 x 113
SAE50-53NAO	■	5	3 701 x 169
SAE50-54NAO	■	5	4 701 x 225
SAE50-55NAO	■	5	5 701 x 281
SAE50-56NAO	■	5	6 701 x 337
SAE50-57NAO	■	5	7 701 x 393

ALPHA 50 Drawer Racks • with Folding Handle

Useful for ALPHA 50 and all boxes up to external dimensions 136x136x53 mm (WxDxH). Front closed.

With Safety Stop			
Cat. No.	L	Number	DxH
	V	Depth	Height (mm)
SAE50-22GAM	■	2	2 308 x 123
SAE50-23GAM	■	2	3 308 x 184
SAE50-24GAM	■	2	4 308 x 245
SAE50-25GAM	■	2	5 308 x 306
SAE50-26GAM	■	2	6 308 x 367
SAE50-27GAM	■	2	7 308 x 428
SAE50-32GAM	■	3	2 439 x 123
SAE50-33GAM	■	3	3 439 x 184
SAE50-34GAM	■	3	4 439 x 245
SAE50-35GAM	■	3	5 439 x 306
SAE50-36GAM	■	3	6 439 x 367
SAE50-37GAM	■	3	7 439 x 428
SAE50-42GAM	■	4	2 569 x 123
SAE50-43GAM	■	4	3 569 x 184
SAE50-44GAM	■	4	4 569 x 245
SAE50-45GAM	■	4	5 569 x 306
SAE50-46GAM	■	4	6 569 x 367
SAE50-47GAM	■	4	7 569 x 428
SAE50-52GAM	■	5	2 710 x 123
SAE50-53GAM	■	5	3 710 x 184
SAE50-54GAM	■	5	4 710 x 245
SAE50-55GAM	■	5	5 710 x 306
SAE50-56GAM	■	5	6 710 x 367
SAE50-57GAM	■	5	7 710 x 428

Without Safety Stop			
Cat. No.	L	Number	DxH
	V	Depth	Height (mm)
SAE50-22GAO	■	2	2 293 x 113
SAE50-23GAO	■	2	3 293 x 169
SAE50-24GAO	■	2	4 293 x 225
SAE50-25GAO	■	2	5 293 x 281
SAE50-26GAO	■	2	6 293 x 337
SAE50-27GAO	■	2	7 293 x 393
SAE50-32GAO	■	3	2 429 x 113
SAE50-33GAO	■	3	3 429 x 169
SAE50-34GAO	■	3	4 429 x 225
SAE50-35GAO	■	3	5 429 x 281
SAE50-36GAO	■	3	6 429 x 337
SAE50-37GAO	■	3	7 429 x 393
SAE50-42GAO	■	4	2 565 x 113
SAE50-43GAO	■	4	3 565 x 169
SAE50-44GAO	■	4	4 565 x 225
SAE50-45GAO	■	4	5 565 x 281
SAE50-46GAO	■	4	6 565 x 337
SAE50-47GAO	■	4	7 565 x 393
SAE50-52GAO	■	5	2 701 x 113
SAE50-53GAO	■	5	3 701 x 169
SAE50-54GAO	■	5	4 701 x 225
SAE50-55GAO	■	5	5 701 x 281
SAE50-56GAO	■	5	6 701 x 337
SAE50-57GAO	■	5	7 701 x 393

With Hand Grip Open Design

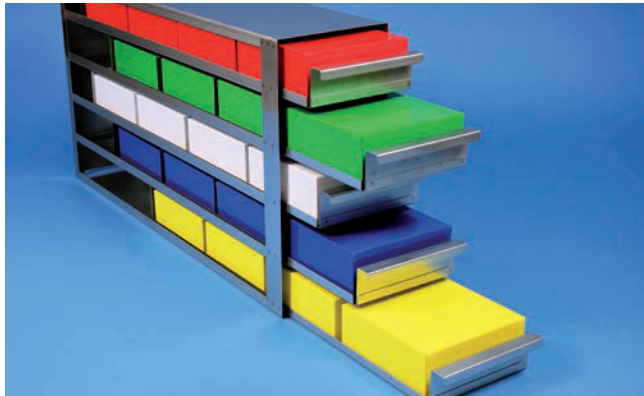

Please complete item number:

B Sides of the drawers approx. 10 mm high. Front with hand grip approx. 40 mm high. Examination of contents possible.

F Sides of the drawers approx. 20 mm high. Front with hand grip to max. height, closed. No examination of contents possible.

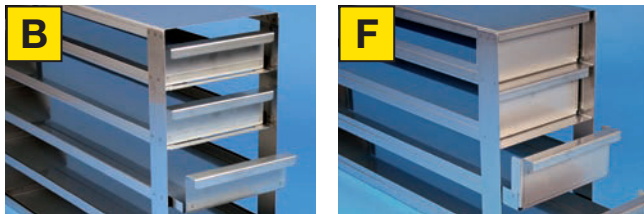

ALPHA 50 Drawer Racks • with Hand Grip

Useful for ALPHA 50 and all boxes up to external dimensions 136x136x53 mm (WxDxH). Base of drawers closed.

With Safety Stop					
Cat. No.	B F	Number	DxH		(mm)
			Depth	Height	
SAE50-22N	MV	2	2	308	123
SAE50-23N	MV	2	3	308	184
SAE50-24N	MV	2	4	308	245
SAE50-25N	MV	2	5	308	306
SAE50-26N	MV	2	6	308	367
SAE50-27N	MV	2	7	308	428
SAE50-32N	MV	3	2	439	123
SAE50-33N	MV	3	3	439	184
SAE50-34N	MV	3	4	439	245
SAE50-35N	MV	3	5	439	306
SAE50-36N	MV	3	6	439	367
SAE50-37N	MV	3	7	439	428
SAE50-42N	MV	4	2	569	123
SAE50-43N	MV	4	3	569	184
SAE50-44N	MV	4	4	569	245
SAE50-45N	MV	4	5	569	306
SAE50-46N	MV	4	6	569	367
SAE50-47N	MV	4	7	569	428
SAE50-52N	MV	5	2	710	123
SAE50-53N	MV	5	3	710	184
SAE50-54N	MV	5	4	710	245
SAE50-55N	MV	5	5	710	306
SAE50-56N	MV	5	6	710	367
SAE50-57N	MV	5	7	710	428

Without Safety Stop					
Cat. No.	B F	Number	DxH		(mm)
			Depth	Height	
SAE50-22N	OV	2	2	308	113
SAE50-23N	OV	2	3	308	169
SAE50-24N	OV	2	4	308	225
SAE50-25N	OV	2	5	308	281
SAE50-26N	OV	2	6	308	337
SAE50-27N	OV	2	7	308	393
SAE50-32N	OV	3	2	439	113
SAE50-33N	OV	3	3	439	169
SAE50-34N	OV	3	4	439	225
SAE50-35N	OV	3	5	439	281
SAE50-36N	OV	3	6	439	337
SAE50-37N	OV	3	7	439	393
SAE50-42N	OV	4	2	569	113
SAE50-43N	OV	4	3	569	169
SAE50-44N	OV	4	4	569	225
SAE50-45N	OV	4	5	569	281
SAE50-46N	OV	4	6	569	337
SAE50-47N	OV	4	7	569	393
SAE50-52N	OV	5	2	710	113
SAE50-53N	OV	5	3	710	169
SAE50-54N	OV	5	4	710	225
SAE50-55N	OV	5	5	710	281
SAE50-56N	OV	5	6	710	337
SAE50-57N	OV	5	7	710	393

With Hand Grip Closed Design

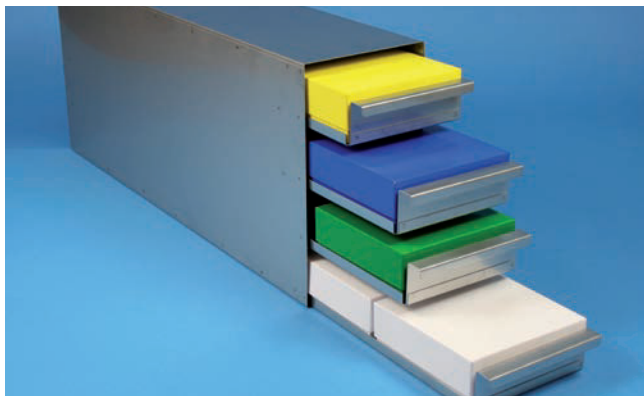

Please complete item number:

B Sides of the drawers approx. 10 mm high. Front with hand grip approx. 40 mm high. Examination of contents possible.

F Sides of the drawers approx. 20 mm high. Front with hand grip to max. height, closed. No examination of contents possible.

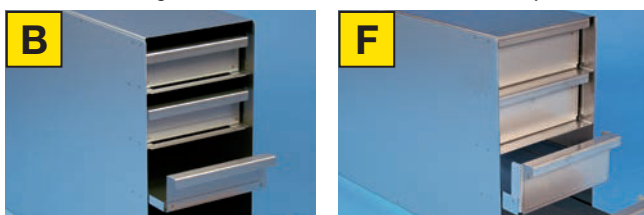

ALPHA 50 Drawer Racks • with Hand Grip

Useful for ALPHA 50 and all boxes up to external dimensions 136x136x53 mm (WxDxH). Base of drawers closed.

With Safety Stop					
Cat. No.	B F	Number	DxH		(mm)
			Depth	Height	
SAE50-22G	MV	2	2	308	123
SAE50-23G	MV	2	3	308	184
SAE50-24G	MV	2	4	308	245
SAE50-25G	MV	2	5	308	306
SAE50-26G	MV	2	6	308	367
SAE50-27G	MV	2	7	308	428
SAE50-32G	MV	3	2	439	123
SAE50-33G	MV	3	3	439	184
SAE50-34G	MV	3	4	439	245
SAE50-35G	MV	3	5	439	306
SAE50-36G	MV	3	6	439	367
SAE50-37G	MV	3	7	439	428
SAE50-42G	MV	4	2	569	123
SAE50-43G	MV	4	3	569	184
SAE50-44G	MV	4	4	569	245
SAE50-45G	MV	4	5	569	306
SAE50-46G	MV	4	6	569	367
SAE50-47G	MV	4	7	569	428
SAE50-52G	MV	5	2	710	123
SAE50-53G	MV	5	3	710	184
SAE50-54G	MV	5	4	710	245
SAE50-55G	MV	5	5	710	306
SAE50-56G	MV	5	6	710	367
SAE50-57G	MV	5	7	710	428

Without Safety Stop					
Cat. No.	B F	Number	DxH		(mm)
			Depth	Height	
SAE50-22G	OV	2	2	308	113
SAE50-23G	OV	2	3	308	169
SAE50-24G	OV	2	4	308	225
SAE50-25G	OV	2	5	308	281
SAE50-26G	OV	2	6	308	337
SAE50-27G	OV	2	7	308	393
SAE50-32G	OV	3	2	439	113
SAE50-33G	OV	3	3	439	169
SAE50-34G	OV	3	4	439	225
SAE50-35G	OV	3	5	439	281
SAE50-36G	OV	3	6	439	337
SAE50-37G	OV	3	7	439	393
SAE50-42G	OV	4	2	569	113
SAE50-43G	OV	4	3	569	169
SAE50-44G	OV	4	4	569	225
SAE50-45G	OV	4	5	569	281
SAE50-46G	OV	4	6	569	337
SAE50-47G	OV	4	7	569	393
SAE50-52G	OV	5	2	710	113
SAE50-53G	OV	5	3	710	169
SAE50-54G	OV	5	4	710	225
SAE50-55G	OV	5	5	710	281
SAE50-56G	OV	5	6	710	337
SAE50-57G	OV	5	7	710	393

ALPHA 25 Drawer Racks

With Grip Rail Open Design 1)

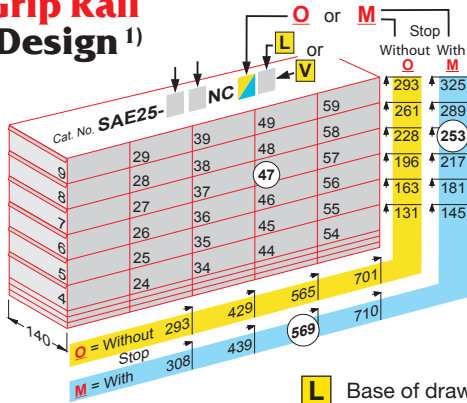

Example: Cat. No. SAE25-47NCMV
For 28 boxes up to a height of 28 mm (e.g. ALPHA 25).
With safety stop. Base of drawers closed.
Dimensions: WxDxH = 140x569x253 mm

L Base of drawer with center opening. Facilitates removal and insertion.
V Base of drawer closed.
See illustrations on page 54

ALPHA 32 Drawer Racks

With Hand Grip Open Design 1)

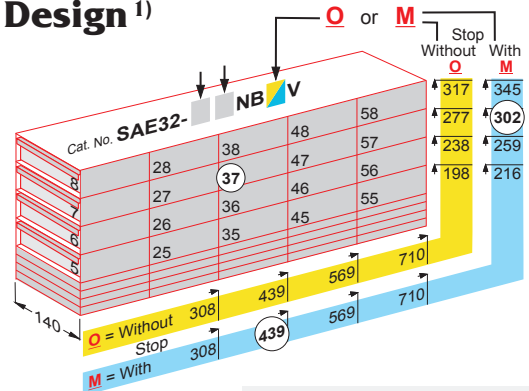

Example: Cat. No. SAE32-37NBMV
For 21 boxes up to a height of 35 mm (e.g. ALPHA 32).
With safety stop. Base of drawers closed.
Dimensions: WxDxH = 140x439x302 mm



Photo: 56-1

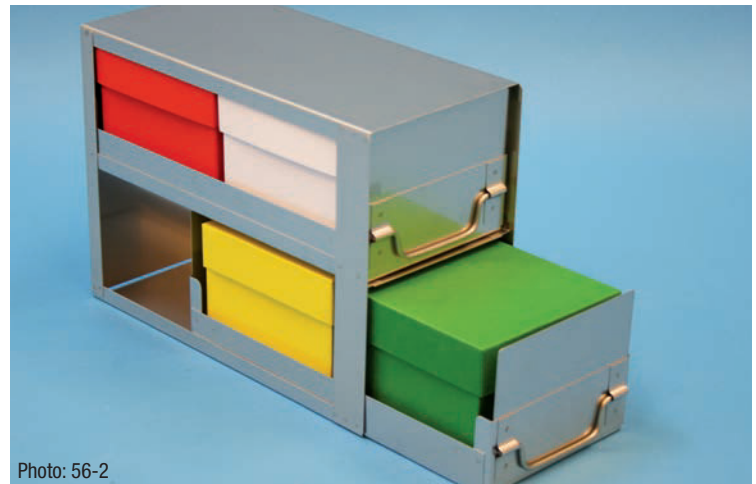

Photo: 56-2



Photo: 56-3

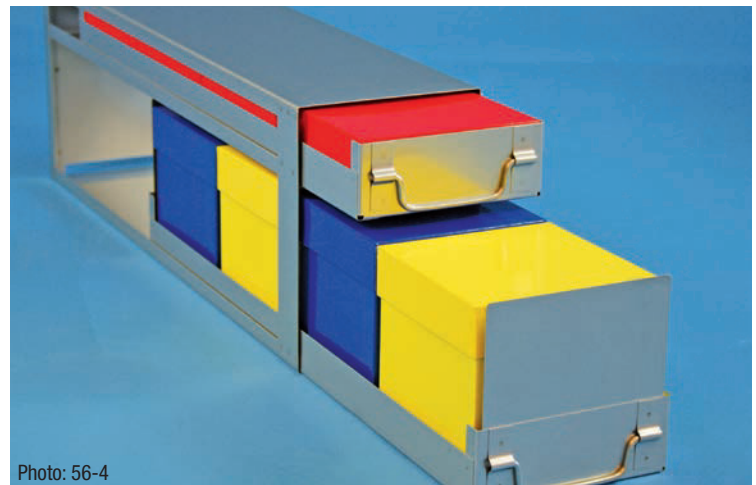

Photo: 56-4



- 1) All drawer racks can also be supplied with a closed design (See illustrations on page 54–55). Please enquire if needed.
- 2) All drawer racks can be produced as a combo drawer rack for shallower boxes (e.g. ALPHA 50) to exploit the interior space of uprights to the maximum.
- 3) The drawer inserts can also be supplied in a modified design »F«. See page 55 for an explanation of the differences.

ALPHA 75 Drawer Racks

With Folding Handle Open Design 1)

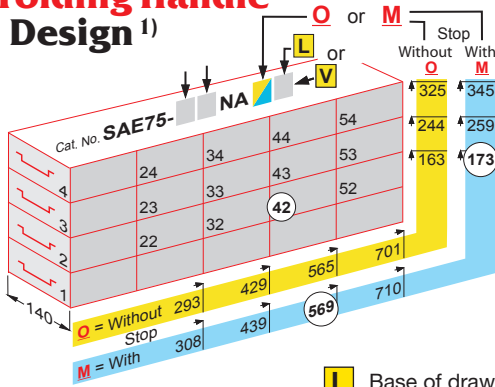

Example: Cat. No. SAE75-42NAML
For 8 boxes up to a height of 78 mm
(e.g. ALPHA 75).
With safety stop. Base of drawers open.
Dimensions: WxDxH = 140x569x173 mm

- L** Base of drawer with center opening. Facilitates removal and insertion.
- V** Base of drawer closed. See illustrations on page 54

ALPHA 75 Drawer Racks

With Hand Grip Version B 3) Open Design 1)

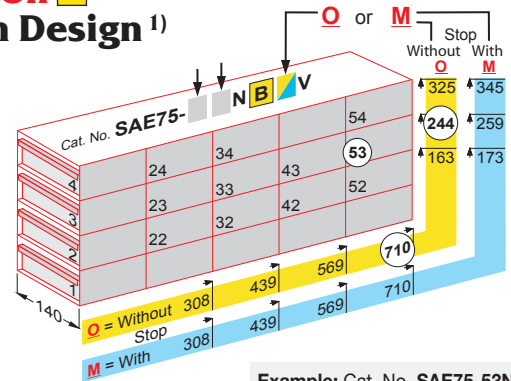

Example: Cat. No. SAE75-53NBV
For 15 boxes up to a height of 78 mm
(e.g. ALPHA 75).
Without safety stop. Base of drawers closed.
Dimensions: WxDxH = 140x710x244 mm

ALPHA 100 Drawer Racks

With Folding Handle Open Design 1)

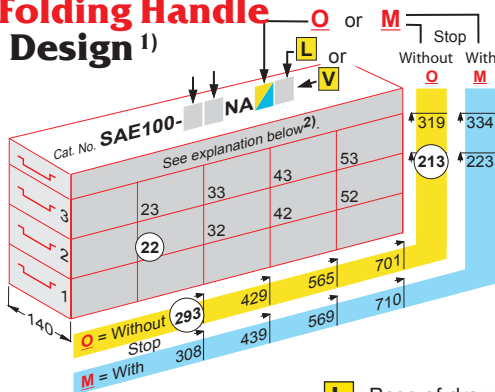

Example: Cat. No. SAE100-22NAOL
For 4 boxes up to a height of 103 mm
(e.g. ALPHA 100).
Without safety stop. Base of drawers open.
Dimensions: WxDxH = 140x293x213 mm

- L** Base of drawer with center opening. Facilitates removal and insertion.
- V** Base of drawer closed. See illustrations on page 54

ALPHA 100 Drawer Racks

With Hand Grip Version B 3) Open Design 1)

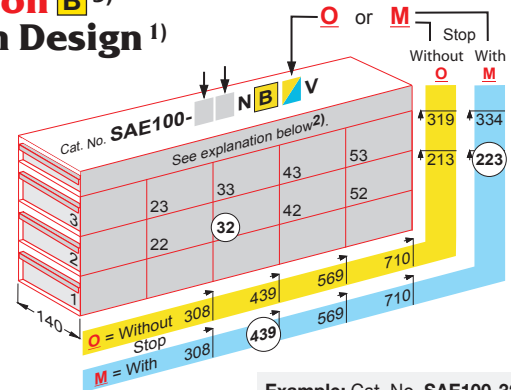

Example: Cat. No. SAE100-32NBV
For 6 boxes up to a height of 103 mm
(e.g. ALPHA 100).
With safety stop. Base of drawers closed.
Dimensions: WxDxH = 140x439x223 mm

ALPHA 130 Drawer Racks

With Folding Handle Open Design 1)

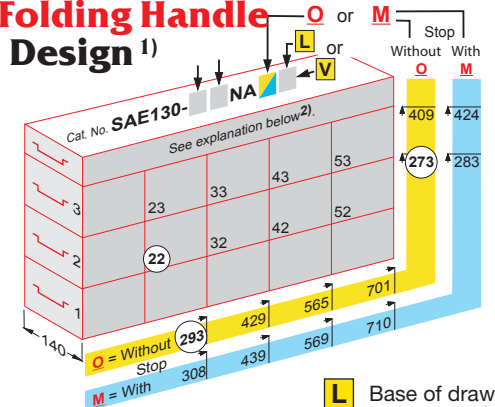

Example: Cat. No. SAE130-22NAOL
For 4 boxes up to a height of 133 mm
(e.g. ALPHA 130).
Without safety stop. Base of drawers open.
Dimensions: WxDxH = 140x293x273 mm

- L** Base of drawer with center opening. Facilitates removal and insertion.
- V** Base of drawer closed. See illustrations on page 54

ALPHA 130 Drawer Racks

With Hand Grip Version B 3) Open Design 1)

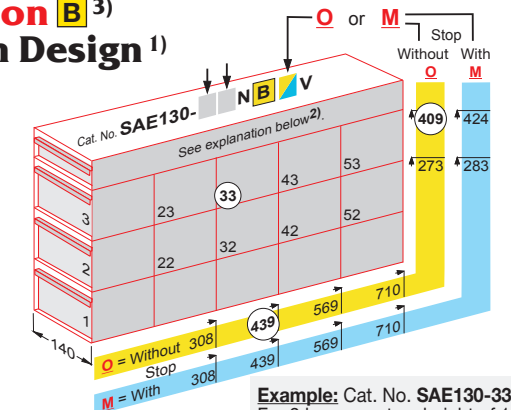

Example: Cat. No. SAE130-33NBV
For 9 boxes up to a height of 133 mm
(e.g. ALPHA 130).
Without safety stop. Base of drawers closed.
Dimensions: WxDxH = 140x439x409 mm

Footnotes 1) and 2) and 3) see page 56.



ALPHA Box long2 136 x 268

Standard box design made of water-repellent fiberboard suitable for ultra-low temperatures. Quality »special« with additional plastic water-proof coating. With lid. External dimensions 136 x 268 mm. Height = inner height.

Other colours and dimensions can be produced on request.

Grid dividers can be ordered separately or can be supplied fitted.

Matching Racks
Please request!

Colour	1 or 2	Heights					
		25 mm	32 mm	50 mm	75 mm	100 mm	130 mm
white	WH 1 standard 2 special	025	032	050	075	100	130
blue	BU 1 standard 2 special	025	032	050	075	100	130
yellow	YE 1 standard 2 special	025	032	050	075	100	130
green	GR 1 standard 2 special	025	032	050	075	100	130
red	RE 1 standard 2 special	025	032	050	075	100	130
orange	OR 1 standard 2 special	025	032	050	075	100	130

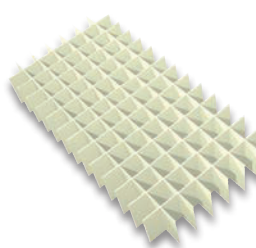

How to determine the item no.:

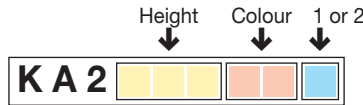

Example 50 mm height, white, standard:

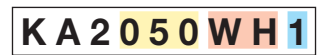

Grid Dividers for ALPHA Box long2

Cells for Tubes	Heights					
	15 mm	25 mm	30 mm	40 mm	65 mm	80 mm
	Cat. No.	Cat. No.	Cat. No.	Cat. No.	Cat. No.	Cat. No.
16x32 up to ca. 7.5 mm Ø	RA20151632N	RA20251632N	RA20301632N	RA20401632N	RA20651632N	RA20801632N
15x30 up to ca. 8.0 mm Ø	RA20151530N	RA20251530N	RA20301530N	RA20401530N	RA20651530N	RA20801530N
14x28 up to ca. 8.7 mm Ø	RA20151428N	RA20251428N	RA20301428N	RA20401428N	RA20651428N	RA20801428N
13x26 up to ca. 9.4 mm Ø	RA20151326N	RA20251326N	RA20301326N	RA20401326N	RA20651326N	RA20801326N
12x24 up to ca. 10.2 mm Ø	RA20151224N	RA20251224N	RA20301224N	RA20401224N	RA20651224N	RA20801224N
11x22 up to ca. 11.2 mm Ø	RA20151122N	RA20251122N	RA20301122N	RA20401122N	RA20651122N	RA20801122N
10x20 up to ca. 12.5 mm Ø	RA20151020N	RA20251020N	RA20301020N	RA20401020N	RA20651020N	RA20801020N
9x18 up to ca. 13.9 mm Ø	RA20150918N	RA20250918N	RA20300918N	RA20400918N	RA20650918N	RA20800918N
8x16 up to ca. 15.7 mm Ø	RA20150816N	RA20250816N	RA20300816N	RA20400816N	RA20650816N	RA20800816N
7x14 up to ca. 17.9 mm Ø	RA20150714N	RA20250714N	RA20300714N	RA20400714N	RA20650714N	RA20800714N
6x12 up to ca. 21.0 mm Ø	RA20150612N	RA20250612N	RA20300612N	RA20400612N	RA20650612N	RA20800612N
5x10 up to ca. 25.5 mm Ø	RA20150510N	RA20250510N	RA20300510N	RA20400510N	RA20650510N	RA20800510N
4x8 up to ca. 32.0 mm Ø	RA20150408N	RA20250408N	RA20300408N	RA20400408N	RA20650408N	RA20800408N
3x6 up to ca. 42.9 mm Ø	RA20150306N	RA20250306N	RA20300306N	RA20400306N	RA20650306N	RA20800306N

When used with item number given in the overview (beginning with "RA2..."), grid dividers are always supplied separately (standard supply).

Instead of the customary method of supplying the box and grid divider separately, the box can be supplied with the grid divider already inserted. For this purpose the code in the item number for the grid divider (highlighted in yellow) must be added to the item number of the box.

Example: ALPHA Box long2 of height 50 mm, white, standard as well as inserted grid divider of height 30 mm with 10x20 cells.

KA2050WH1 + 0301020N = Cat. No. KA2050WH10301020N



Matching Racks

Vertical Racks
page 50
Horizontal Racks
page 51-52
Drawer Racks
page 54-57
Upright Bins
page 53

FoxBox 136x136 mm • 10x10 Grid Divider

Plastic-coated fiberboard box, waterproof. With alphanumeric ID code on the side as well as numeric ID code 1-100 on the lid. Inserted grid divider 10x10 for 100 tubes up to approx. 12.5 mm Ø. Height of grid divider 30 mm. Other colours and dimensions can be produced on request.

Cat. No.	Ext. Height	Grid Divider	Colour	Inner Height
6508	52 mm	10x10	white	48 mm
6509	75 mm	10x10	white	71 mm
6510	95 mm	10x10	white	91 mm

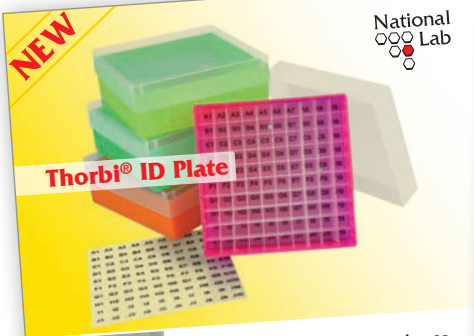

Thorbi® ID Plate

Sample Identification for Cryoboxes

Insert plate is made of transparent polypropylene (PP) with alphanumeric or numeric ID code. Stable and just 0.5 mm thick. Simply place under the grid divider in cryoboxes without plastic or cardboard. Polypropylene is resistant to low temperatures down to -196 °C. Pack contains 10 pieces in a bag with press closure.

Dimensions Thorbi® ID Plate	For Box 133 x 133 mm			For Box 136 x 136 mm		
	ID Code	Cat. No.		ID Code	Cat. No.	
Alphanumeric	9x9	A1-9	LCBC0909AN	A1-9	LCAC0909AN	
	10x10	A1-10	LCBC1010AN	A1-10	LCAC1010AN	
	Numeric	9x9	1-81	LCBC0909NU	1-81	LCAC0909NU
10x10		1-100	LCBC1010NU	1-100	LCAC1010NU	



3 x 3 holes for 25 ml Eppendorf Conical Tubes*

Cat. No.	Colour
KES92-CO20NA	natural
KES92-CO20NY	neon-yellow
KES92-CO20NB	neon-blue
KES92-CO20NG	neon-green
KES92-CO20NP	neon-red/pink
KES92-CO20NO	neon-orange
KES92-CO20B	black/black*

5 x 5 holes for 5 ml Eppendorf Conical Tubes*

Cat. No.	Colour
KES67-CO5NA	natural
KES67-CO5NY	neon-yellow
KES67-CO5NB	neon-blue
KES67-CO5NG	neon-green
KES67-CO5NP	neon-red/pink
KES67-CO5NO	neon-orange
KES67-CO5B	black/black*

EPPi® MAX
The ALPHA Box made of PP*

New: 136 x 136 mm

Box without Grid Divider
EPPi® MAX 50 height 52 mm
EPPi® MAX 45 height 45-53 mm

The Classic Box: 133 x 133 mm
EPPi® 50 height 52 mm
EPPi® 45 height 45-53 mm

Matching Grid Dividers H = 30 mm

EPPi® MAX and all Boxes 136 x 136 mm

EPPi® Box and all Boxes 133 x 133 mm

Why do only 81 cryo tubes fit into your cryoboxes?

The answer is quite simple: it's because you're not yet using our super-alm EPPi cryo tubes, which not only enable you to store 100 tubes in our standard boxes. You probably won't find anyone more or else established themselves as the standard throughout the world. Now, in any case, this expensive waste of space is over!

Your specimen material is valuable, rare or even unique. You are already using optical for contamination-free tubes with an inner thread and silicon O-ring, there is no further need to keep making this 100 EPPi cryo tubes with internal thread fit into the standard box of 133x133 mm. Check out the benefits for yourself!

- GMP-oriented production under cleanroom conditions.
- Extensive and very detailed quality control measures during the production process.
- Batch inspection system with leak test to validate the process.
- Exclusive use of FDA-approved polypropylene for in vitro diagnostics. Both tubes and screw top are made of the same medical-grade material to achieve a 100% leak.
- The outer thread with QuickLock screw closure and fine screw top with self-cleaning lip enable the tubes to be closed very quickly and opened with only half a rotation.
- Packaged in resealable upright pouches with batch label.
- EPPi cryo tubes can be printed individually to meet customer requirements. Personalized barcodes and QR codes are also possible.

Matchbox®
Vertical Racks
Horizontal Racks
Drawer Racks
Upright Bins

EPPi® 67 / 5x5 • height 61 mm fx
Inner height 60 mm. With two hole inserts 5x5 holes for 5 ml reaction vessels or centrifuge tubes 5 ml for 20 centrifuge tubes 15 ml up to 17 mm Ø. With alphanumeric ID code. Alphabetic ID code on request.

EPPi® 128 / 5x5 • height 128 mm fx
Inner height 125 mm. With two hole inserts 5x5 for 25 centrifuge tubes 15 ml up to 17 mm Ø. With alphanumeric ID code. Alphabetic ID code on request.

EPPi® 128 / 3x3 • height 128 mm fx
Inner height 125 mm. With two hole inserts 3x3 holes for 9 centrifuge tubes 15 ml up to 17 mm Ø. With alphanumeric ID code. Alphabetic ID code on request.

EPPi® 128 / 10 / 1 • height 128 mm fx
Inner height 125 mm. With two hole inserts for 10 centrifuge tubes, 10 x 50 ml (up to 30 mm Ø) and 6 x 15 ml (up to 17 mm Ø). Without ID code.

Anniversary Offer EPPi® Drawer Racks

SE50-4ANBOV
EPPi® drawer rack 45 x 50, for 16 boxes up to 133x133x53 mm, 4 boxes in depth / 4 boxes in height, stainless steel, open design, hand grip, without safety stop, base closed. External dimension WxDxH = 140x567x231 mm
• Price without boxes: EUR 89,60
• Instead of EUR 112,00 per pc.
• EPPi® Cryoboxes on request

SE50-4SNBOV
EPPi® drawer rack 45 x 50, for 20 boxes up to 133x133x53 mm, 4 boxes in depth / 5 boxes in height, stainless steel, open design, hand grip, without safety stop, base closed. External dimension = 140x567x346 mm
• Price without boxes: EUR 99,60
• Instead of EUR 117,00 per pc.
• EPPi® Cryoboxes on request

SE50-4BNBOV
EPPi® drawer rack 45 x 50, for 24 boxes up to 133x133x53 mm, 4 boxes in depth / 6 boxes in height, stainless steel, open design, hand grip, without safety stop, base closed. External dimension = 140x567x346 mm
• Price without boxes: EUR 104,00
• Instead of EUR 130,00 per pc.
• EPPi® Cryoboxes on request

• Prices excl. VAT
• Delivery 2-3W ex works
• Payment: 90 days net

Offer subject to confirmation. Only while stocks last. Subject to prior sale.

BRAVO Box made of Fiberboard

133 x 133 mm • Cryo and Storage Boxes

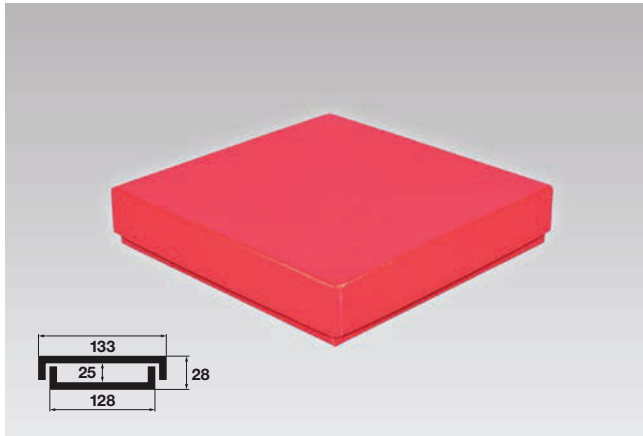

BRAVO Box 133x133 • Type 25 mm

Standard box design made of water-repellent fiberboard suitable for ultra-low temperatures. Quality »special« with additional plastic water-proof coating. With lid. Other colours and dimensions can be produced on request.

Standard		Special	
Cat. No.	Colour	Cat. No.	Colour
KB1025WH1	white	KB1025WH2	white
KB1025BU1	blue	KB1025BU2	blue
KB1025YE1	yellow	KB1025YE2	yellow
KB1025GR1	green	KB1025GR2	green
KB1025RE1	red	KB1025RE2	red
KB1025OR1	orange	KB1025OR2	orange

Grid dividers can be ordered separately or can be supplied fitted (see page 61).

Matching Racks

Vertical Racks
page 62
Horizontal Racks
page 63
Drawer Racks
Please request!
Upright Bins
page 47 EPPi®

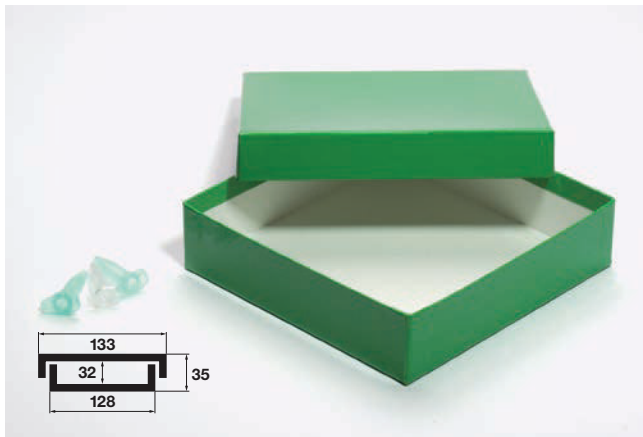

BRAVO Box 133x133 • Type 32 mm

Standard box design made of water-repellent fiberboard suitable for ultra-low temperatures. Quality »special« with additional plastic water-proof coating. With lid. Other colours and dimensions can be produced on request.

Standard		Special	
Cat. No.	Colour	Cat. No.	Colour
KB1032WH1	white	KB1032WH2	white
KB1032BU1	blue	KB1032BU2	blue
KB1032YE1	yellow	KB1032YE2	yellow
KB1032GR1	green	KB1032GR2	green
KB1032RE1	red	KB1032RE2	red
KB1032OR1	orange	KB1032OR2	orange

Grid dividers can be ordered separately or can be supplied fitted (see page 61).

Matching Racks

Vertical Racks
page 62
Horizontal Racks
page 63
Drawer Racks
page 44 EPPi®
Upright Bins
page 47 EPPi®

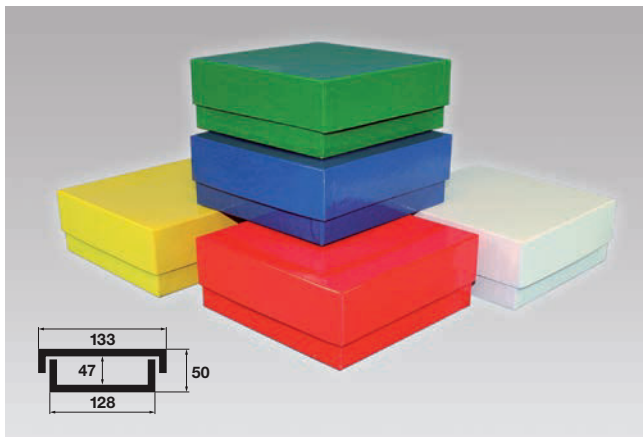

BRAVO Box 133x133 • Type 50 mm

Standard box design made of water-repellent fiberboard suitable for ultra-low temperatures. Quality »special« with additional plastic water-proof coating. Other colours and dimensions can be produced on request.

Standard		Special	
Cat. No.	Colour	Cat. No.	Colour
KB1050WH1X	white	KB1050WH2X	white
KB1050BU1X	blue	KB1050BU2X	blue
KB1050YE1X	yellow	KB1050YE2X	yellow
KB1050GR1X	green	KB1050GR2X	green
KB1050RE1X	red	KB1050RE2X	red
KB1050OR1X	orange	KB1050OR2X	orange

Grid dividers can be ordered separately or can be supplied fitted (see page 61).

Matching Racks

Vertical Racks
page 62
Horizontal Racks
page 63
Drawer Racks
page 42–43 EPPi®
Upright Bins
page 47 EPPi®

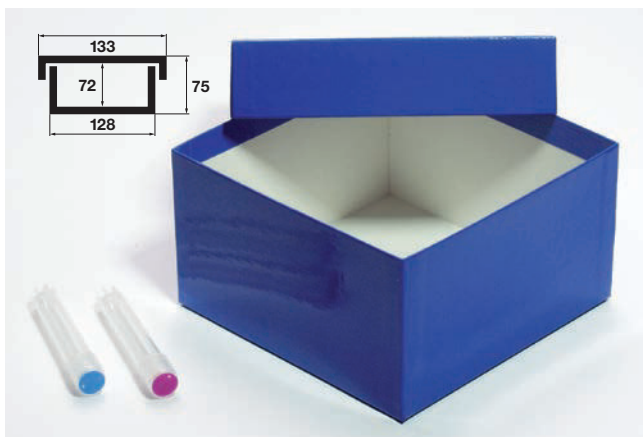

BRAVO Box 133x133 • Type 75 mm

Standard box design made of water-repellent fiberboard suitable for ultra-low temperatures. Quality »special« with additional plastic water-proof coating. With lid. Other colours and dimensions can be produced on request.

Standard		Special	
Cat. No.	Colour	Cat. No.	Colour
KB1075WH1	white	KB1075WH2	white
KB1075BU1	blue	KB1075BU2	blue
KB1075YE1	yellow	KB1075YE2	yellow
KB1075GR1	green	KB1075GR2	green
KB1075RE1	red	KB1075RE2	red
KB1075OR1	orange	KB1075OR2	orange

Grid dividers can be ordered separately or can be supplied fitted (see page 61).

Matching Racks

Vertical Racks
page 62
Horizontal Racks
page 63
Drawer Racks
page 44 EPPi®
Upright Bins
page 47 EPPi®

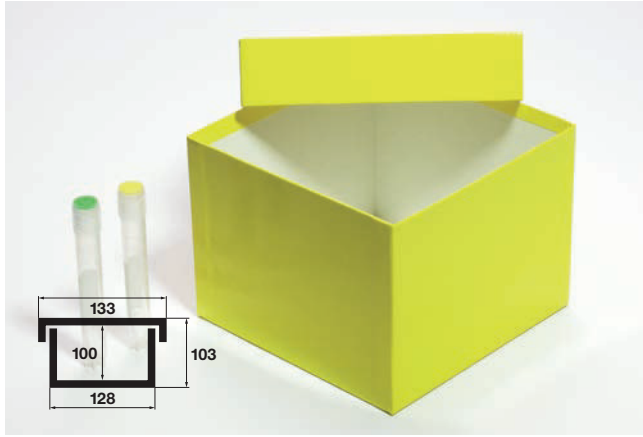

BRAVO Box 133x133 • Type 100 mm

Standard box design made of water-repellent fiberboard suitable for ultra-low temperatures. Quality »special« with additional plastic water-proof coating. With lid. Other colours and dimensions can be produced on request.

Standard		Special	
Cat. No.	Colour	Cat. No.	Colour
KB1100WH1	white	KB1100WH2	white
KB1100BU1	blue	KB1100BU2	blue
KB1100YE1	yellow	KB1100YE2	yellow
KB1100GR1	green	KB1100GR2	green
KB1100RE1	red	KB1100RE2	red
KB1100OR1	orange	KB1100OR2	orange

Grid dividers can be ordered separately or can be supplied fitted (see below).

Matching Racks

Vertical Racks
page 62

Horizontal Racks
page 63

Drawer Racks
page 45 EPPi®

Upright Bins
page 47 EPPi®

Please enquire for BRAVO Box with height of 110 mm.

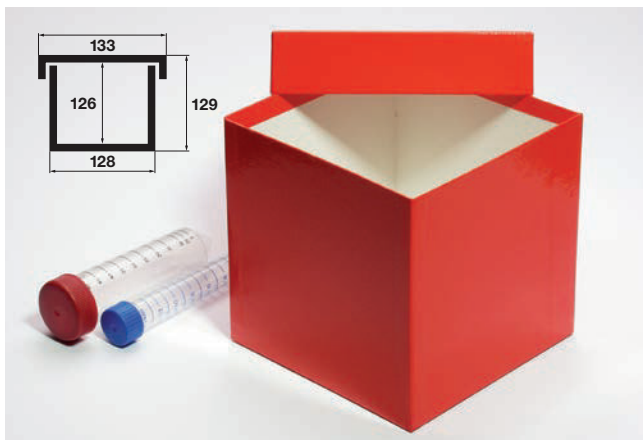

BRAVO Box 133x133 • Type 130 mm

Standard box design made of water-repellent fiberboard suitable for ultra-low temperatures. Quality »special« with additional plastic water-proof coating. With lid. Other colours and dimensions can be produced on request.

Standard		Special	
Cat. No.	Colour	Cat. No.	Colour
KB1130WH1	white	KB1130WH2	white
KB1130BU1	blue	KB1130BU2	blue
KB1130YE1	yellow	KB1130YE2	yellow
KB1130GR1	green	KB1130GR2	green
KB1130RE1	red	KB1130RE2	red
KB1130OR1	orange	KB1130OR2	orange

Grid dividers can be ordered separately or can be supplied fitted (see below).

Matching Racks

Vertical Racks
page 62

Horizontal Racks
page 63

Drawer Racks
page 46 EPPi®

Upright Bins
page 47 EPPi®

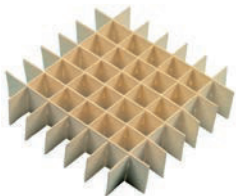

Grid Dividers made of Fiberboard

for BRAVO Box and all boxes up to 133 x 133 mm

Matching grid dividers made of Polypropylene (PP) see EPPi Box on page 37.

Cells for Tubes	Heights					
	15 mm	25 mm	30 mm	40 mm	65 mm	80 mm
	Cat. No.	Cat. No.	Cat. No.	Cat. No.	Cat. No.	Cat. No.
16x16 up to ca. 7.2 mm Ø	RB10151616N	RB10251616N	RB10301616N	RB10401616N	RB10651616N	RB10801616N
15x15 up to ca. 7.7 mm Ø	RB10151515N	RB10251515N	RB10301515N	RB10401515N	RB10651515N	RB10801515N
14x14 up to ca. 8.3 mm Ø	RB10151414N	RB10251414N	RB10301414N	RB10401414N	RB10651414N	RB10801414N
13x13 up to ca. 9.0 mm Ø	RB10151313N	RB10251313N	RB10301313N	RB10401313N	RB10651313N	RB10801313N
12x12 up to ca. 9.8 mm Ø	RB10151212N	RB10251212N	RB10301212N	RB10401212N	RB10651212N	RB10801212N
11x11 up to ca. 10.8 mm Ø	RB10151111N	RB10251111N	RB10301111N	RB10401111N	RB10651111N	RB10801111N
10x10 up to ca. 12.0 mm Ø	RB10151010N	RB10251010N	RB10301010N	RB10401010N	RB10651010N	RB10801010N
9x9 up to ca. 13.0 mm Ø	RB10150909N	RB10250909N	RB10300909N	RB10400909N	RB10650909N	RB10800909N
8x8 up to ca. 15.0 mm Ø	RB10150808N	RB10250808N	RB10300808N	RB10400808N	RB10650808N	RB10800808N
7x7 up to ca. 17.3 mm Ø	RB10150707N	RB10250707N	RB10300707N	RB10400707N	RB10650707N	RB10800707N
6x6 up to ca. 20.3 mm Ø	RB10150606N	RB10250606N	RB10300606N	RB10400606N	RB10650606N	RB10800606N
5x5 up to ca. 24.5 mm Ø	RB10150505N	RB10250505N	RB10300505N	RB10400505N	RB10650505N	RB10800505N
4x4 up to ca. 30.8 mm Ø	RB10150404N	RB10250404N	RB10300404N	RB10400404N	RB10650404N	RB10800404N
3x3 up to ca. 41.2 mm Ø	RB10150303N	RB10250303N	RB10300303N	RB10400303N	RB10650303N	RB10800303N

When used with item number given in the overview (beginning with "RB1..."), grid dividers are always supplied separately (standard supply).

Instead of the customary method of supplying the box and grid divider separately, the box can be supplied with the grid divider already inserted. For this purpose the code in the item number for the grid divider (highlighted in yellow) must be added to the item number of the box.

Example: BRAVO Box with 50 mm height, white, standard as well as inserted grid divider of height 30 mm with 9x9 cells.

KB1050WH1 + 0300909N = Cat. No. KB1050WH10300909N



BRAVO 25 Vertical Racks

Useful for BRAVO 25 and all boxes up to external dimensions 133x133x28 mm (WxDxH).
2 boxes in each bay,
total number in ().

Cat. No.	Bays	Height (mm)
TB25-08AN2	4 (8)	238
TB25-10AN2	5 (10)	296
TB25-12AN2	6 (12)	354
TB25-14AN2	7 (14)	412
TB25-16AN2	8 (16)	470
TB25-18AN2	9 (18)	528
TB25-20AN2	10 (20)	586
TB25-22AN2	11 (22)	644
TB25-24AN2	12 (24)	702
TB25-26AN2	13 (26)	760



BRAVO 32 Vertical Racks

Useful for BRAVO 32 and all boxes up to external dimensions 133x133x35 mm (WxDxH).
2 boxes in each bay,
total number in ().

Cat. No.	Bays	Height (mm)
TB32-06AN2	3 (6)	222
TB32-08AN2	4 (8)	294
TB32-10AN2	5 (10)	366
TB32-12AN2	6 (12)	438
TB32-14AN2	7 (14)	510
TB32-16AN2	8 (16)	582
TB32-18AN2	9 (18)	654
TB32-20AN2	10 (20)	726

BRAVO 50 Vertical Racks

Useful for BRAVO 50 and all boxes up to external dimensions 133x133x53 mm (WxDxH).

Cat. No.	Bays	Height (mm)
TE50-04AN	4	226
TE50-05AN	5	281
TE50-06AN	6	336
TE50-07AN	7	391
TE50-08AN	8	446
TE50-09AN	9	501
TE50-10AN	10	556
TE50-11AN	11	611
TE50-12AN	12	666
TE50-13AN	13	721
TE50-14AN	14	776



BRAVO 75 Vertical Racks

Useful for BRAVO 75 and all boxes up to external dimensions 133x133x78 mm (WxDxH).

Cat. No.	Bays	Height (mm)
TB75-03AN	3	246
TB75-04AN	4	326
TB75-05AN	5	406
TB75-06AN	6	486
TB75-07AN	7	566
TB75-08AN	8	646
TB75-09AN	9	726

BRAVO 100 Vertical Racks

Useful for BRAVO 100 and all boxes up to external dimensions 133x133x103 mm (WxDxH).

Cat. No.	Bays	Height (mm)
TE102-03AN	3	321
TE102-04AN	4	426
TE102-05AN	5	531
TE102-06AN	6	636
TE102-07AN	7	741

BRAVO 110 Vertical Racks

Useful for BRAVO 110 and all boxes up to external dimensions 133x133x113 mm (WxDxH).

Cat. No.	Bays	Height (mm)
TB110-03AN	3	351
TB110-04AN	4	466
TB110-05AN	5	581
TB110-06AN	6	696
TB110-07AN	7	811



BRAVO 130 Vertical Racks

Useful for BRAVO 130 and all boxes up to external dimensions 133x133x133 mm (WxDxH).

Cat. No.	Bays	Height (mm)
TB130-03AN	3	411
TB130-04AN	4	546
TB130-05AN	5	681



EPPi Ident Identification Tags see page 19.

 Folding handle positioned crosswise as standard.
Alternatives: Folding handle positioned lengthwise or hand grip. Please enquire if needed.

 All vertical racks can be supplied with a safety rod if required.
This increases the depth by 7 mm to 145 mm. Please enquire if needed.



BRAVO 25 Horizontal Racks

Useful for BRAVO 25 and all boxes up to external dimensions 133x133x28 mm (WxDxH).
2 boxes in each bay,
total number in ().

Cat. No.	Bays Depth x Height	Dimensions Dx H (mm)
SB25-2x08AN2	2 x 4 (16)	278x236
SB25-2x10AN2	2 x 5 (20)	278x294
SB25-2x12AN2	2 x 6 (24)	278x352
SB25-3x08AN2	3 x 4 (24)	414x236
SB25-3x10AN2	3 x 5 (30)	414x294
SB25-3x12AN2	3 x 6 (36)	414x352
SB25-4x08AN2	4 x 4 (32)	549x236
SB25-4x10AN2	4 x 5 (40)	549x294
SB25-4x12AN2	4 x 6 (48)	549x352
SB25-5x08AN2	5 x 4 (40)	685x236
SB25-5x10AN2	5 x 5 (50)	685x294
SB25-5x12AN2	5 x 6 (60)	685x352



Folding handle positioned vertically as standard.
Alternatives: Folding handle positioned horizontally or hand grip. Please enquire if needed.

BRAVO 75 Horizontal Racks

Useful for BRAVO 75 and all boxes up to external dimensions 133x133x78 mm (WxDxH).

Cat. No.	Bays Depth x Height	Dimensions Dx H (mm)
SB75-32AN	3 x 2	414x164
SB75-33AN	3 x 3	414x244
SB75-34AN	3 x 4	414x324
SB75-42AN	4 x 2	549x164
SB75-43AN	4 x 3	549x244
SB75-44AN	4 x 4	549x324
SB75-52AN	5 x 2	685x164
SB75-53AN	5 x 3	685x244
SB75-54AN	5 x 4	685x324

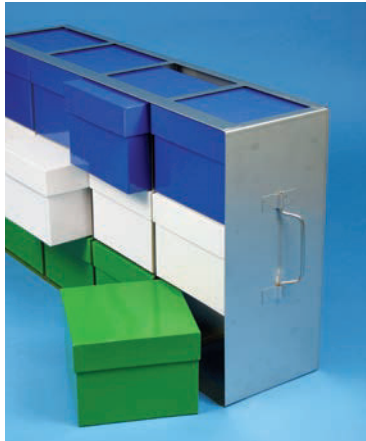

BRAVO 130 Horizontal Racks

Useful for BRAVO 130 and all boxes up to external dimensions 133x133x133 mm (WxDxH).

Cat. No.	Bays Depth x Height	Dimensions Dx H (mm)
SB130-32AN	3 x 2	414x279
SB130-33AN	3 x 3	414x409
SB130-42AN	4 x 2	549x279
SB130-43AN	4 x 3	549x409
SB130-52AN	5 x 2	685x279
SB130-53AN	5 x 3	685x409



BRAVO 32 Horizontal Racks

Useful for BRAVO 32 and all boxes up to external dimensions 133x133x35 mm (WxDxH).
2 boxes in each bay,
total number in ().

Cat. No.	Bays Depth x Height	Dimensions Dx H (mm)
SB32-36AN2	3x3 (18)	414x220
SB32-38AN2	3x4 (24)	414x292
SB32-46AN2	4x3 (24)	549x220
SB32-48AN2	4x4 (32)	549x292
SB32-56AN2	5x3 (30)	685x220
SB32-58AN2	5x4 (40)	685x292

BRAVO 100 Horizontal Racks

Useful for BRAVO 100 and all boxes up to external dimensions 133x133x103 mm (WxDxH).

Cat. No.	Bays Depth x Height	Dimensions Dx H (mm)
SE102-32AN	3 x 2	414x214
SE102-33AN	3 x 3	414x319
SE102-42AN	4 x 2	549x214
SE102-43AN	4 x 3	549x319
SE102-52AN	5 x 2	685x214
SE102-53AN	5 x 3	685x319



All horizontal racks can be supplied with safety rods if required. Add 7 mm to width and 3 mm to height. Please enquire if needed.



Photo: 63-1

BRAVO 50 Horizontal Racks

Useful for BRAVO 50 and all boxes up to external dimensions 133x133x53 mm (WxDxH).

Cat. No.	Bays Depth x Height	Dimensions Dx H (mm)
SE50-24AN	2 x 4	278x224
SE50-25AN	2 x 5	278x279
SE50-26AN	2 x 6	278x334
SE50-33AN	3 x 3	414x169
SE50-34AN	3 x 4	414x224
SE50-35AN	3 x 5	414x279
SE50-36AN	3 x 6	414x334
SE50-37AN	3 x 7	414x389
SE50-43AN	4 x 3	549x169
SE50-44AN	4 x 4	549x224
SE50-45AN	4 x 5	549x279
SE50-46AN	4 x 6	549x334
SE50-47AN	4 x 7	549x389
SE50-53AN	5 x 3	685x169
SE50-54AN	5 x 4	685x224
SE50-55AN	5 x 5	685x279
SE50-56AN	5 x 6	685x334
SE50-57AN	5 x 7	685x389

BRAVO 110 Horizontal Racks

Useful for BRAVO 110 and all boxes up to external dimensions 133x133x113 mm (WxDxH).

Cat. No.	Bays Depth x Height	Dimensions Dx H (mm)
SB110-32AN	3 x 2	414x234
SB110-33AN	3 x 3	414x349
SB110-42AN	4 x 2	549x234
SB110-43AN	4 x 3	549x349
SB110-52AN	5 x 2	685x234
SB110-53AN	5 x 3	685x349



Photo: 63-2

Matching horizontal racks without and with one intermediate shelf see page 41 EPPi.



BRAVO Box long2 133 x 257

Standard box design made of water-repellent fiberboard suitable for ultralow temperatures. Quality »special« with additional plastic water-proof coating. With lid. External dimensions 133 x 257 mm. Height = inner height.
Other colours and dimensions can be produced on request.
Grid dividers can be ordered separately or can be supplied fitted.

Matching Racks
Please request!

Colour	1 or 2	Heights					
		25 mm	32 mm	50 mm*	75 mm	100 mm	130 mm
white	WH 1 standard 2 special	025	032	050	075	100	130
blue	BU 1 standard 2 special	025	032	050	075	100	130
yellow	YE 1 standard 2 special	025	032	050	075	100	130
green	GR 1 standard 2 special	025	032	050	075	100	130
red	RE 1 standard 2 special	025	032	050	075	100	130
orange	OR 1 standard 2 special	025	032	050	075	100	130

* Produced traditionally to the American Design.
(Actual internal height: 45 mm)

How to determine
item no.:

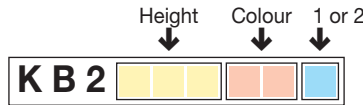

Example 50 mm height,
white, standard:

KB 2 0 50 WH 1

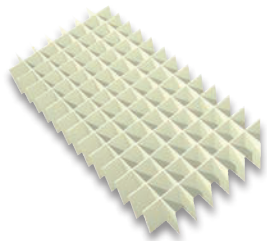

Grid Dividers for BRAVO Box long2

Cells for Tubes	Heights						
	15 mm	25 mm	30 mm	40 mm	65 mm	80 mm	
	Cat. No.	Cat. No.	Cat. No.	Cat. No.	Cat. No.	Cat. No.	
16x32 up to ca. 7.2 mm Ø	RB20151632N	RB20251632N	RB20301632N	RB20401632N	RB20651632N	RB20801632N	
15x30 up to ca. 7.7 mm Ø	RB20151530N	RB20251530N	RB20301530N	RB20401530N	RB20651530N	RB20801530N	
14x28 up to ca. 8.3 mm Ø	RB20151428N	RB20251428N	RB20301428N	RB20401428N	RB20651428N	RB20801428N	
13x26 up to ca. 9.0 mm Ø	RB20151326N	RB20251326N	RB20301326N	RB20401326N	RB20651326N	RB20801326N	
12x24 up to ca. 9.8 mm Ø	RB20151224N	RB20251224N	RB20301224N	RB20401224N	RB20651224N	RB20801224N	
11x22 up to ca. 10.8 mm Ø	RB20151122N	RB20251122N	RB20301122N	RB20401122N	RB20651122N	RB20801122N	
10x20 up to ca. 12.0 mm Ø	RB20151020N	RB20251020N	RB20301020N	RB20401020N	RB20651020N	RB20801020N	
9x18 up to ca. 13.0 mm Ø	RB20150918N	RB20250918N	RB20300918N	RB20400918N	RB20650918N	RB20800918N	
8x16 up to ca. 15.0 mm Ø	RB20150816N	RB20250816N	RB20300816N	RB20400816N	RB20650816N	RB20800816N	
7x14 up to ca. 17.3 mm Ø	RB20150714N	RB20250714N	RB20300714N	RB20400714N	RB20650714N	RB20800714N	
6x12 up to ca. 20.3 mm Ø	RB20150612N	RB20250612N	RB20300612N	RB20400612N	RB20650612N	RB20800612N	
5x10 up to ca. 24.5 mm Ø	RB20150510N	RB20250510N	RB20300510N	RB20400510N	RB20650510N	RB20800510N	
4x8 up to ca. 30.8 mm Ø	RB20150408N	RB20250408N	RB20300408N	RB20400408N	RB20650408N	RB20800408N	
3x6 up to ca. 41.2 mm Ø	RB20150306N	RB20250306N	RB20300306N	RB20400306N	RB20650306N	RB20800306N	

When used with item number given in the overview (beginning with "RB2..."), grid dividers are always supplied separately (standard supply).

Instead of the customary method of supplying the box and grid divider separately, the box can be supplied with the grid divider already inserted. For this purpose the code in the item number for the grid divider (highlighted in yellow) must be added to the item number of the box.

Example: BRAVO Box long2 with 50 mm height, white, standard as well as inserted grid divider of height 30 mm with 9x18 cells.

KB2050WH1 + 0300918N = Cat. No. KB2050WH10300918N

DELTA Box made of Fiberboard

133 x 133 mm • with extended lid

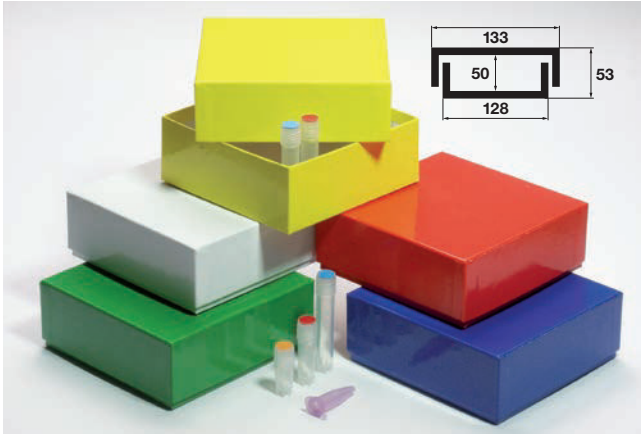

DELTA Box 133x133 • height 50 mm

Standard box design made of water-repellent fiberboard suitable for ultra-low temperatures. Quality »special« with additional plastic water-proof coating. With extended lid. Height = inner height. Other colours and dimensions can be produced on request.

Standard		Special	
Cat. No.	Colour	Cat. No.	Colour
KD1050WH1	white	KD1050WH2	white
KD1050BU1	blue	KD1050BU2	blue
KD1050YE1	yellow	KD1050YE2	yellow
KD1050GR1	green	KD1050GR2	green
KD1050RE1	red	KD1050RE2	red
KD1050OR1	orange	KD1050OR2	orange

Grid dividers can be ordered separately or can be supplied fitted (see page 61 BRAVO).

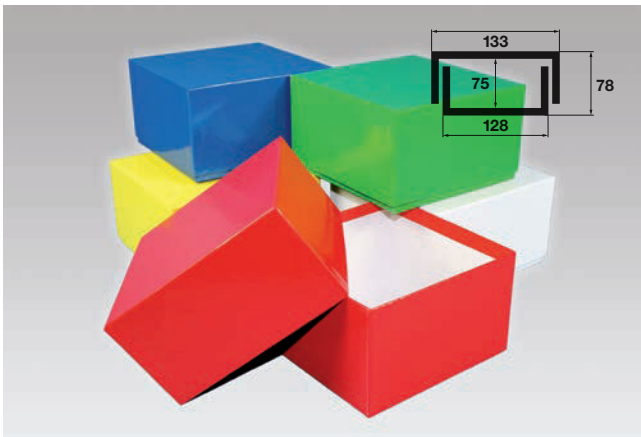

DELTA Box 133x133 • height 75 mm

Standard box design made of water-repellent fiberboard suitable for ultra-low temperatures. Quality »special« with additional plastic water-proof coating. With extended lid. Height = inner height. Other colours and dimensions can be produced on request.

Standard		Special	
Cat. No.	Colour	Cat. No.	Colour
KD1075WH1	white	KD1075WH2	white
KD1075BU1	blue	KD1075BU2	blue
KD1075YE1	yellow	KD1075YE2	yellow
KD1075GR1	green	KD1075GR2	green
KD1075RE1	red	KD1075RE2	red
KD1075OR1	orange	KD1075OR2	orange

Grid dividers can be ordered separately or can be supplied fitted (see page 61 BRAVO).

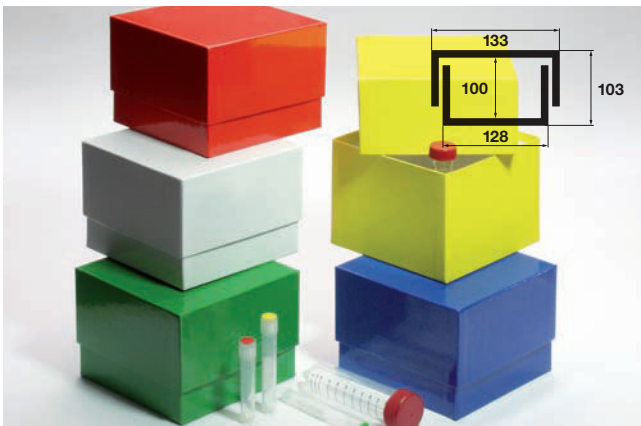

DELTA Box 133x133 • height 100 mm

Standard box design made of water-repellent fiberboard suitable for ultra-low temperatures. Quality »special« with additional plastic water-proof coating. With extended lid. Height = inner height. Other colours and dimensions can be produced on request.

Standard		Special	
Cat. No.	Colour	Cat. No.	Colour
KD1100WH1	white	KD1100WH2	white
KD1100BU1	blue	KD1100BU2	blue
KD1100YE1	yellow	KD1100YE2	yellow
KD1100GR1	green	KD1100GR2	green
KD1100RE1	red	KD1100RE2	red
KD1100OR1	orange	KD1100OR2	orange

Grid dividers can be ordered separately or can be supplied fitted (see page 61 BRAVO).

Please enquire for DELTA Box with height of 110 mm.

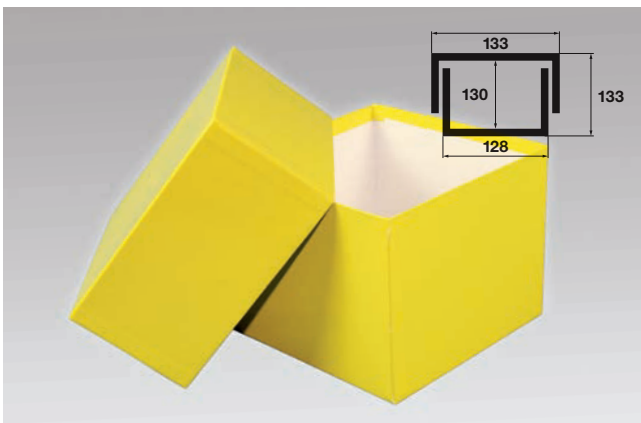

DELTA Box 133x133 • height 130 mm

Standard box design made of water-repellent fiberboard suitable for ultra-low temperatures. Quality »special« with additional plastic water-proof coating. With extended lid. Height = inner height. Other colours and dimensions can be produced on request.

Standard		Special	
Cat. No.	Colour	Cat. No.	Colour
KD1130WH1	white	KD1130WH2	white
KD1130BU1	blue	KD1130BU2	blue
KD1130YE1	yellow	KD1130YE2	yellow
KD1130GR1	green	KD1130GR2	green
KD1130RE1	red	KD1130RE2	red
KD1130OR1	orange	KD1130OR2	orange

Grid dividers can be ordered separately or can be supplied fitted (see page 61 BRAVO).

Matching Racks

Vertical Racks
page 62 BRAVO

Horizontal Racks
page 63 BRAVO

Drawer Racks
page 42–43 EPPi®

Upright Bins
page 47 EPPi®

Matching Racks

Vertical Racks
page 62 BRAVO

Horizontal Racks
page 63 BRAVO

Drawer Racks
page 44 EPPi®

Upright Bins
page 47 EPPi®

Matching Racks

Vertical Racks
page 62 BRAVO

Horizontal Racks
page 63 BRAVO

Drawer Racks
page 45 EPPi®

Upright Bins
page 47 EPPi®

Matching Racks

Vertical Racks
page 62 BRAVO

Horizontal Racks
page 63 BRAVO

Drawer Racks
page 46 EPPi®

Upright Bins
page 47 EPPi®

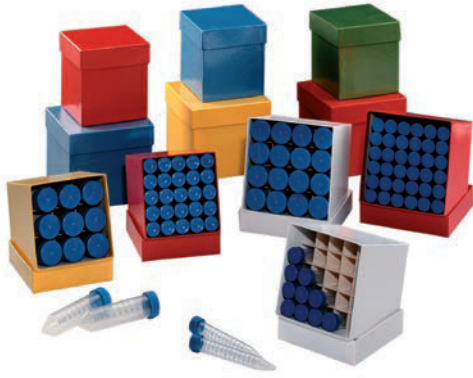

CellBox Cryo and Storage Boxes for 15 ml and 50 ml tubes

Useful for all tubes up to approx. 22 mm (15 ml) or 34 mm (50 ml) diameter and 125 mm maximum length. Standard box water-repellent fiberboard boxes suitable for ultra-low temperatures. Quality >special< with additional water-proof coating made of plastic. With and without inserted grid divider. Dimensions = External dimensions incl. lid.

		15 ml	
		CellBox Mini 5 x 5 Cells (122x122x128 mm)	CellBox Maxi 6 x 6 Cells (148x148x128 mm)
Colour	1 or 2	Cat. No.	Cat. No.
white	WH 1 standard 2 special	KCMi1WH1-5x5 KCMi1WH2-5x5	KCMA1WH1-6x6 KCMA1WH2-6x6
blue	BU 1 standard 2 special	KCMi1BU1-5x5 KCMi1BU2-5x5	KCMA1BU1-6x6 KCMA1BU2-6x6
yellow	YE 1 standard 2 special	KCMi1YE1-5x5 KCMi1YE2-5x5	KCMA1YE1-6x6 KCMA1YE2-6x6
green	GR 1 standard 2 special	KCMi1GR1-5x5 KCMi1GR2-5x5	KCMA1GR1-6x6 KCMA1GR2-6x6
red	RE 1 standard 2 special	KCMi1RE1-5x5 KCMi1RE2-5x5	KCMA1RE1-6x6 KCMA1RE2-6x6

		50 ml	
		CellBox Mini 3 x 3 Cells (122x122x128 mm)	CellBox Maxi 4 x 4 Cells (148x148x128 mm)
Colour	1 or 2	Cat. No.	Cat. No.
white	WH 1 standard 2 special	KCMi1WH1-3x3 KCMi1WH2-3x3	KCMA1WH1-4x4 KCMA1WH2-4x4
blue	BU 1 standard 2 special	KCMi1BU1-3x3 KCMi1BU2-3x3	KCMA1BU1-4x4 KCMA1BU2-4x4
yellow	YE 1 standard 2 special	KCMi1YE1-3x3 KCMi1YE2-3x3	KCMA1YE1-4x4 KCMA1YE2-4x4
green	GR 1 standard 2 special	KCMi1GR1-3x3 KCMi1GR2-3x3	KCMA1GR1-4x4 KCMA1GR2-4x4
red	RE 1 standard 2 special	KCMi1RE1-3x3 KCMi1RE2-3x3	KCMA1RE1-4x4 KCMA1RE2-4x4



		15 ml	
		CellBox Mini long 5 x 10 Cells (122x237x128 mm)	CellBox Maxi long 6 x 12 Cells (148x287x128 mm)
Colour	1 or 2	Cat. No.	Cat. No.
white	WH 1 standard 2 special	KCMi2WH1-5x10 KCMi2WH2-5x10	KCMA2WH1-6x12 KCMA2WH2-6x12
blue	BU 1 standard 2 special	KCMi2BU1-5x10 KCMi2BU2-5x10	KCMA2BU1-6x12 KCMA2BU2-6x12
yellow	YE 1 standard 2 special	KCMi2YE1-5x10 KCMi2YE2-5x10	KCMA2YE1-6x12 KCMA2YE2-6x12
green	GR 1 standard 2 special	KCMi2GR1-5x10 KCMi2GR2-5x10	KCMA2GR1-6x12 KCMA2GR2-6x12
red	RE 1 standard 2 special	KCMi2RE1-5x10 KCMi2RE2-5x10	KCMA2RE1-6x12 KCMA2RE2-6x12

		50 ml	
		CellBox Mini long 3 x 6 Cells (122x237x128 mm)	CellBox Maxi long 4 x 8 Cells (148x287x128 mm)
Colour	1 or 2	Cat. No.	Cat. No.
white	WH 1 standard 2 special	KCMi2WH1-3x6 KCMi2WH2-3x6	KCMA2WH1-4x8 KCMA2WH2-4x8
blue	BU 1 standard 2 special	KCMi2BU1-3x6 KCMi2BU2-3x6	KCMA2BU1-4x8 KCMA2BU2-4x8
yellow	YE 1 standard 2 special	KCMi2YE1-3x6 KCMi2YE2-3x6	KCMA2YE1-4x8 KCMA2YE2-4x8
green	GR 1 standard 2 special	KCMi2GR1-3x6 KCMi2GR2-3x6	KCMA2GR1-4x8 KCMA2GR2-4x8
red	RE 1 standard 2 special	KCMi2RE1-3x6 KCMi2RE2-3x6	KCMA2RE1-4x8 KCMA2RE2-4x8



		15 ml	
		CellBox Mini without Cells (122x122x128 mm)	CellBox Maxi without Cells (148x148x128 mm)
Colour	1 or 2	Cat. No.	Cat. No.
white	WH 1 standard 2 special	KCMi1WH1 KCMi1WH2	KCMA1WH1 KCMA1WH2
blue	BU 1 standard 2 special	KCMi1BU1 KCMi1BU2	KCMA1BU1 KCMA1BU2
yellow	YE 1 standard 2 special	KCMi1YE1 KCMi1YE2	KCMA1YE1 KCMA1YE2
green	GR 1 standard 2 special	KCMi1GR1 KCMi1GR2	KCMA1GR1 KCMA1GR2
red	RE 1 standard 2 special	KCMi1RE1 KCMi1RE2	KCMA1RE1 KCMA1RE2

		50 ml	
		CellBox Mini long without Cells (122x237x128 mm)	CellBox Maxi long without Cells (148x287x128 mm)
Colour	1 or 2	Cat. No.	Cat. No.
white	WH 1 standard 2 special	KCMi2WH1 KCMi2WH2	KCMA2WH1 KCMA2WH2
blue	BU 1 standard 2 special	KCMi2BU1 KCMi2BU2	KCMA2BU1 KCMA2BU2
yellow	YE 1 standard 2 special	KCMi2YE1 KCMi2YE2	KCMA2YE1 KCMA2YE2
green	GR 1 standard 2 special	KCMi2GR1 KCMi2GR2	KCMA2GR1 KCMA2GR2
red	RE 1 standard 2 special	KCMi2RE1 KCMi2RE2	KCMA2RE1 KCMA2RE2

CellBoxes in different colours on request.

Grid Dividers for CellBox (only for empty boxes or repeat orders)

	Cells	Cat. No.		Cells	Cat. No.		Cells	Cat. No.		Cells	Cat. No.				
Mini	15 ml	5x5	RC0900505N	Mini	50 ml	3x3	RC0900303N	Maxi	15 ml	6x6	RC0900606N	Maxi	50 ml	4x4	RC0900404N
Mini long	15 ml	5x10	RC0900510N	Mini long	50 ml	3x6	RC0900306N	Maxi long	15 ml	6x12	RC0900612N	Maxi long	50 ml	4x8	RC0900408N
Mini long	10 ml	8x12	RC0900812N												



* Dimensions = External dimensions incl. lid

CellBox Mini Vertical Racks

Useful for CellBox Mini and all boxes up to external dimensions 122x122x128 mm (WxDxH).*

Cat. No.	Bays	WxDxH (mm)
TCMi1-02FN	2	127x127x266
TCMi1-03FN	3	127x127x396
TCMi1-04FN	4	127x127x526
TCMi1-05FN	5	127x127x656
TCMi1-06FN	6	127x127x786

CellBox Mini long Vertical Racks

Useful for CellBox Mini long and all boxes up to external dimensions 122x237x128 mm (WxDxH).*

Cat. No.	Bays	WxDxH (mm)
TCMi2-02FN	2	127x245x266
TCMi2-03FN	3	127x245x396
TCMi2-04FN	4	127x245x526
TCMi2-05FN	5	127x245x656
TCMi2-06FN	6	127x245x786

CellBox Maxi Vertical Racks

Useful for CellBox Maxi and all boxes up to external dimensions 148x148x128 mm (WxDxH).*

Cat. No.	Bays	WxDxH (mm)
TCMa1-02AN	2	153x153x266
TCMa1-03AN	3	153x153x396
TCMa1-04AN	4	153x153x526
TCMa1-05AN	5	153x153x656
TCMa1-06AN	6	153x153x786

CellBox Maxi long Vertical Racks

Useful for CellBox Maxi long and all boxes up to external dimensions 148x287x128 mm (WxDxH).*

Cat. No.	Bays	WxDxH (mm)
TCMa2-02AN	2	153x296x266
TCMa2-03AN	3	153x296x396
TCMa2-04AN	4	153x296x526
TCMa2-05AN	5	153x296x656
TCMa2-06AN	6	153x296x786



Vertical racks with folding handle positioned crosswise as standard.

Alternatives: Folding handle positioned lengthwise or hand grip. Please enquire if needed.

CellBox Mini Horizontal Racks

Useful for CellBox Mini and all boxes up to external dimensions 122x122x128 mm (WxDxH).*

Cat. No.	Bays Depth x Height	W x D x H (mm)
SCMi1-22AN	2 x 2	128x258x264
SCMi1-23AN	2 x 3	128x258x394
SCMi1-32AN	3 x 2	128x384x264
SCMi1-33AN	3 x 3	128x384x394
SCMi1-42AN	4 x 2	128x509x264
SCMi1-43AN	4 x 3	128x509x394
SCMi1-52AN	5 x 2	128x635x264
SCMi1-53AN	5 x 3	128x635x394

CellBox Maxi Horizontal Racks

Useful for CellBox Maxi and all boxes up to external dimensions 148x148x128 mm (WxDxH).*

Cat. No.	Bays Depth x Height	W x D x H (mm)
SCMa1-22AN	2 x 2	154x310x264
SCMa1-23AN	2 x 3	154x310x394
SCMa1-32AN	3 x 2	154x462x264
SCMa1-33AN	3 x 3	154x462x394
SCMa1-42AN	4 x 2	154x613x264
SCMa1-43AN	4 x 3	154x613x394
SCMa1-52AN	5 x 2	154x765x264
SCMa1-53AN	5 x 3	154x765x394

CellBox Mini long Horizontal Racks

Useful for CellBox Mini long and all boxes up to external dimensions 122x237x128 mm (WxDxH).*

Cat. No.	Bays Depth x Height	W x D x H (mm)
SCMi2-22AN	2 x 2	128x494x264
SCMi2-23AN	2 x 3	128x494x394
SCMi2-32AN	3 x 2	128x738x264
SCMi2-33AN	3 x 3	128x738x394

CellBox Maxi long Horizontal Racks

Useful for CellBox Maxi long and all boxes up to external dimensions 148x287x128 mm (WxDxH).*

Cat. No.	Bays Depth x Height	W x D x H (mm)
SCMa2-22AN	2 x 2	154x596x264
SCMa2-23AN	2 x 3	154x596x394



Horizontal racks with folding handle positioned vertically as standard.

Alternatives: Folding handle positioned horizontally or hand grip. Please enquire if needed.

Drawer Racks for CellBox on request.



MIKE Box 142 x 142

Standard box design made of water-repellent fiberboard suitable for ultralow temperatures. Quality »special« with additional plastic water-proof coating. With lid. External dimensions 142 x 142 mm. Height = inner height.

Other colours and dimensions can be produced on request.

Grid dividers can be ordered separately or can be supplied fitted.

Matching Racks
Please request!

Colour	1 or 2	Heights					
		25 mm	32 mm	50 mm	75 mm	100 mm	130 mm
white	WH 1 standard 2 special	025	032	050	075	100	130
blue	BU 1 standard 2 special	025	032	050	075	100	130
yellow	YE 1 standard 2 special	025	032	050	075	100	130
green	GR 1 standard 2 special	025	032	050	075	100	130
red	RE 1 standard 2 special	025	032	050	075	100	130
orange	OR 1 standard 2 special	025	032	050	075	100	130

How to determine the item no.:

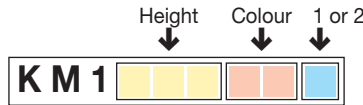

Example 50 mm height, white, standard:

KM1050WH1

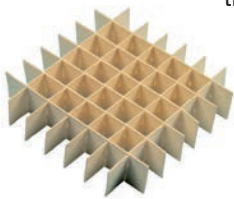

Grid Dividers for MIKE Box

Cells for Tubes	Heights					
	15 mm	25 mm	30 mm	40 mm	65 mm	80 mm
	Cat. No.	Cat. No.	Cat. No.	Cat. No.	Cat. No.	Cat. No.
16x16 up to ca. 7.7 mm Ø	RM10151616N	RM10251616N	RM10301616N	RM10401616N	RM10651616N	RM10801616N
15x15 up to ca. 8.3 mm Ø	RM10151515N	RM10251515N	RM10301515N	RM10401515N	RM10651515N	RM10801515N
14x14 up to ca. 9.0 mm Ø	RM10151414N	RM10251414N	RM10301414N	RM10401414N	RM10651414N	RM10801414N
13x13 up to ca. 9.7 mm Ø	RM10151313N	RM10251313N	RM10301313N	RM10401313N	RM10651313N	RM10801313N
12x12 up to ca. 10.6 mm Ø	RM10151212N	RM10251212N	RM10301212N	RM10401212N	RM10651212N	RM10801212N
11x11 up to ca. 11.6 mm Ø	RM10151111N	RM10251111N	RM10301111N	RM10401111N	RM10651111N	RM10801111N
10x10 up to ca. 12.8 mm Ø	RM10151010N	RM10251010N	RM10301010N	RM10401010N	RM10651010N	RM10801010N
9x9 up to ca. 14.3 mm Ø	RM10150909N	RM10250909N	RM10300909N	RM10400909N	RM10650909N	RM10800909N
8x8 up to ca. 17.0 mm Ø	RM10150808N	RM10250808N	RM10300808N	RM10400808N	RM10650808N	RM10800808N
7x7 up to ca. 18.6 mm Ø	RM10150707N	RM10250707N	RM10300707N	RM10400707N	RM10650707N	RM10800707N
6x6 up to ca. 21.8 mm Ø	RM10150606N	RM10250606N	RM10300606N	RM10400606N	RM10650606N	RM10800606N
5x5 up to ca. 26.3 mm Ø	RM10150505N	RM10250505N	RM10300505N	RM10400505N	RM10650505N	RM10800505N
4x4 up to ca. 33.0 mm Ø	RM10150404N	RM10250404N	RM10300404N	RM10400404N	RM10650404N	RM10800404N
3x3 up to ca. 44.2 mm Ø	RM10150303N	RM10250303N	RM10300303N	RM10400303N	RM10650303N	RM10800303N

When used with item number given in the overview (beginning with "RM1..."), grid dividers are always supplied separately (standard supply).

Instead of the customary method of supplying the box and grid divider separately, the box can be supplied with the grid divider already inserted. For this purpose the code in the item number for the grid divider (highlighted in yellow) must be added to the item number of the box.

Example: MIKE Box with 50 mm height, white, standard as well as inserted grid divider of height 30 mm with 10x10 cells.

KM1050WH1 + 0301010N = Cat. No. KM1050WH10301010N



NANU Box 76 x 76

Standard box design made of water-repellent fiberboard suitable for ultra-low temperatures. Quality »special« with additional plastic water-proof coating. With extended lid. External dimensions 76 x 76 mm. Height = inner height. Other colours and dimensions can be produced on request. Grid dividers can be ordered separately or can be supplied fitted.

Matching Racks
Please request!

Colour	1 or 2	Heights					
		25 mm	32 mm	50 mm	75 mm	100 mm	130 mm
white	WH 1 standard 2 special	025	032	050	075	100	130
blue	BU 1 standard 2 special	025	032	050	075	100	130
yellow	YE 1 standard 2 special	025	032	050	075	100	130
green	GR 1 standard 2 special	025	032	050	075	100	130
red	RE 1 standard 2 special	025	032	050	075	100	130
orange	OR 1 standard 2 special	025	032	050	075	100	130

How to determine the item no.:

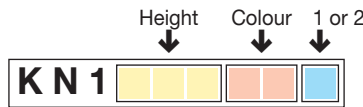

Example 50 mm height, white, standard:

KN1050WH1

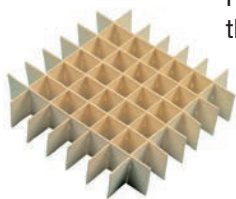

Grid Dividers for NANU Box

Cells for Tubes	Heights					
	15 mm	25 mm	30 mm	40 mm	65 mm	80 mm
7x7 up to ca. 8.0 mm Ø	RN10150707N	RN10250707N	RN10300707N	RN10400707N	RN10650707N	RN10800707N
6x6 up to ca. 10.0 mm Ø	RN10150606N	RN10250606N	RN10300606N	RN10400606N	RN10650606N	RN10800606N
5x5 up to ca. 13.5 mm Ø	RN10150505N	RN10250505N	RN10300505N	RN10400505N	RN10650505N	RN10800505N
4x4 up to ca. 15.0 mm Ø	RN10150404N	RN10250404N	RN10300404N	RN10400404N	RN10650404N	RN10800404N
3x3 up to ca. 21.0 mm Ø	RN10150303N	RN10250303N	RN10300303N	RN10400303N	RN10650303N	RN10800303N

When used with item number given in the overview (beginning with "RN1..."), grid dividers are always supplied separately (standard supply).

Instead of the customary method of supplying the box and grid divider separately, the box can be supplied with the grid divider already inserted. For this purpose the code in the item number for the grid divider (highlighted in yellow) must be added to the item number of the box.

Example: NANU Box with 50 mm height, white, standard as well as inserted grid divider of height 30 mm with 5x5 cells.

KN1050WH1 + 0300505N = Cat. No. KN1050WH10300505N

NANU 50 Vertical Racks • 81x81 mm (WxD)

NANU 50 Horizontal Racks • Width 82 mm

» Useful for NANU 50 and all boxes up to external dimensions 76x76x53 mm (WxDxH), e.g. Cryobox KPC50-C25. «

i All vertical and horizontal racks can be supplied with a safety rod if required. Please note changes in dimensions: Depth vertical racks plus 7 mm. Depth horizontal racks plus 7 mm, height plus 3 mm. Please enquire if needed.

Cat. No.	Bays	Height (mm)
TN50-06FN	6	336
TN50-07FN	7	391
TN50-08FN	8	446
TN50-09FN	9	501
TN50-10FN	10	556
TN50-11FN	11	611
TN50-12FN	12	666
TN50-13FN	13	721



Cat. No.	Bays D x H	Dimensions D x H (mm)
SN50-44AN	4 x 4	325x224
SN50-45AN	4 x 5	325x279
SN50-46AN	4 x 6	325x334
SN50-54AN	5 x 4	405x224
SN50-55AN	5 x 5	405x279
SN50-56AN	5 x 6	405x334
SN50-64AN	6 x 4	484x224
SN50-65AN	6 x 5	484x279



Additional vertical and horizontal racks – also with safety rod – as well as drawer racks for NANU Box on request.

For Microtiter Plates or DeepWells of all familiar brands.



Up to 18 mm plate height

Single		Double	
35	706	35x2	706
34	686	34x2	686
33	666	33x2	666
32	646	32x2	646
31	626	31x2	626
30	606	30x2	606
29	586	29x2	586
28	566	28x2	566
27	546	27x2	546
26	526	26x2	526
25	506	25x2	506
24	486	24x2	486
23	466	23x2	466
22	446	22x2	446
21	426	21x2	426
20	406	20x2	406
19	386	19x2	386
18	366	18x2	366
17	346	17x2	346
16	326	16x2	326
15	306	15x2	306

Example:
Cat. No. TM18-22AN
Vertical rack
with 22 bays
(Individual bays)

Example:
Cat. No. TM18-19x2AN
Vertical rack with
19 bays (2 plates next to
each other in each bay)

Personal Rack

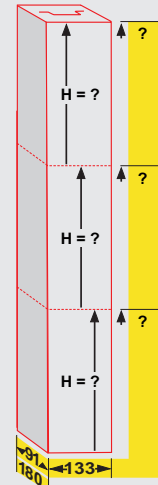

If the examples shown here do not meet your storage needs, please let us know your requirements:

- Maximum height of the rack?
- Height of the plate stack or required internal height of the bays?
- How many racks are needed?

You will receive an individual quotation from us.



All vertical racks can be supplied with a safety rod if required. The depth increases by 7 mm as a result. Please enquire if needed.

Up to 26 mm plate height

Single		Double	
28	790	28x2	790
27	762	27x2	762
26	734	26x2	734
25	706	25x2	706
24	678	24x2	678
23	650	23x2	650
22	622	22x2	622
21	594	21x2	594
20	566	20x2	566
19	538	19x2	538
18	510	18x2	510
17	482	17x2	482
16	454	16x2	454
15	426	15x2	426
14	398	14x2	398
13	370	13x2	370
12	342	12x2	342
11	314	11x2	314
10	286	10x2	286

Cat. No. TM26-...AN Cat. No. TM26-...x.AN

Up to 33 mm plate height

Single		Double	
22	776	22x2	776
21	741	21x2	741
20	706	20x2	706
19	671	19x2	671
18	636	18x2	636
17	601	17x2	601
16	566	16x2	566
15	531	15x2	531
14	496	14x2	496
13	461	13x2	461
12	426	12x2	426
11	391	11x2	391
10	356	10x2	356
09	321	09x2	321
08	286	08x2	286

Cat. No. TM33-...AN Cat. No. TM33-...x.AN

Up to 39 mm plate height

Single		Double	
19	785	19x2	785
18	744	18x2	744
17	703	17x2	703
16	662	16x2	662
15	621	15x2	621
14	580	14x2	580
13	539	13x2	539
12	498	12x2	498
11	457	11x2	457
10	416	10x2	416
09	375	09x2	375
08	334	08x2	334
07	293	07x2	293

Cat. No. TM39-...AN Cat. No. TM39-...x.AN

Up to 45 mm plate height

Single		Double	
16	758	16x2	758
15	711	15x2	711
14	664	14x2	664
13	617	13x2	617
12	570	12x2	570
11	523	11x2	523
10	476	10x2	476
09	429	09x2	429
08	382	08x2	382
07	335	07x2	335
06	288	06x2	288

Cat. No. TM45-...AN Cat. No. TM45-...x.AN

Up to 53 mm plate height

Single		Double	
14	776	14x2	776
13	721	13x2	721
12	666	12x2	666
11	611	11x2	611
10	556	10x2	556
09	501	09x2	501
08	446	08x2	446
07	391	07x2	391
06	336	06x2	336

Cat. No. TM53-...AN Cat. No. TM53-...x.AN

Up to 58 mm plate height

Single		Double	
12	726	12x2	726
11	666	11x2	666
10	606	10x2	606
09	546	09x2	546
08	486	08x2	486
07	426	07x2	426
06	366	06x2	366
05	306	05x2	306

Cat. No. TM58-...AN Cat. No. TM58-...x.AN

For Microtiter Plates or DeepWells of all familiar brands.



Up to 18 mm plate height

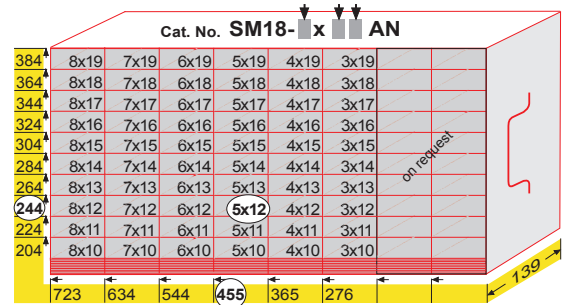

Up to 26 mm plate height

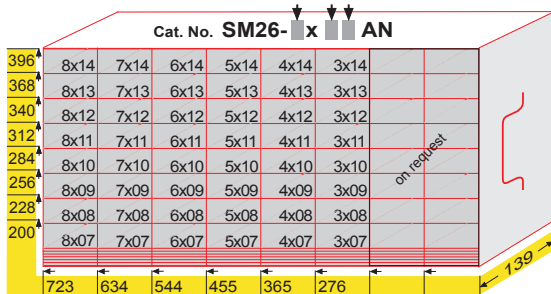

Up to 33 mm plate height

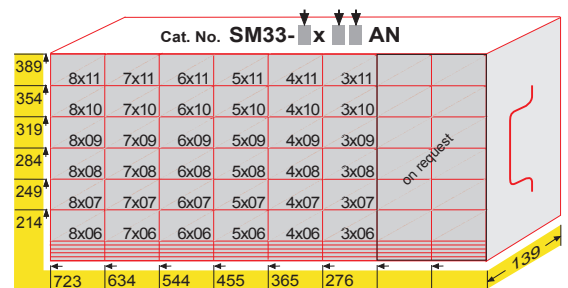

Up to 39 mm plate height

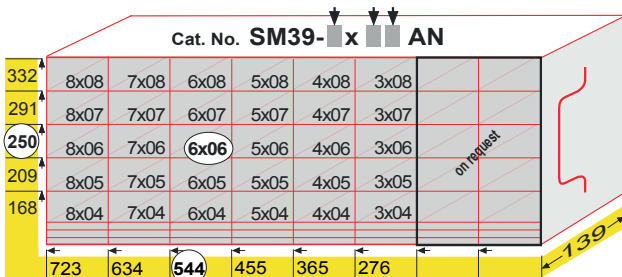

Up to 45 mm plate height

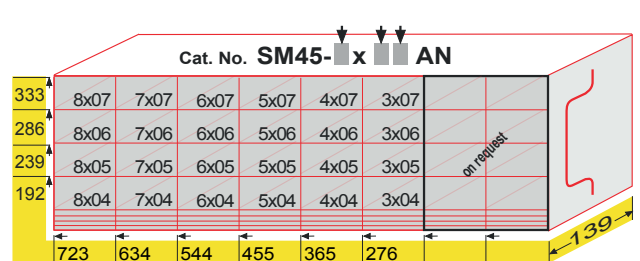

Example: Cat. No. **SM39 - 6 x 0 6 AN**

MT horizontal racks with 36 bays. For plates or stacks up to 39 mm in height. Dimensions: WxDxH = 139x544x250 mm

Up to 53 mm plate height

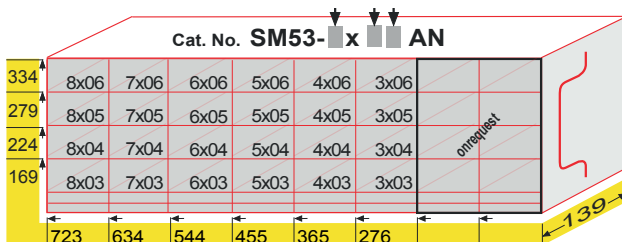

Up to 58 mm plate height

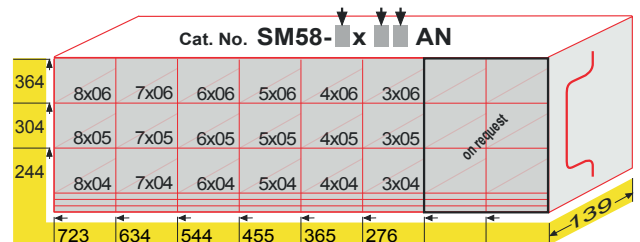

Folding handle positioned vertically as standard.
Alternatives: Folding handle positioned horizontally or hand grip.
 Please enquire if needed.



All horizontal racks can be supplied with safety rods if required.
 Add 3 mm to height.
 Please enquire if needed.

For Microtiter Plates or DeepWells of all familiar brands.

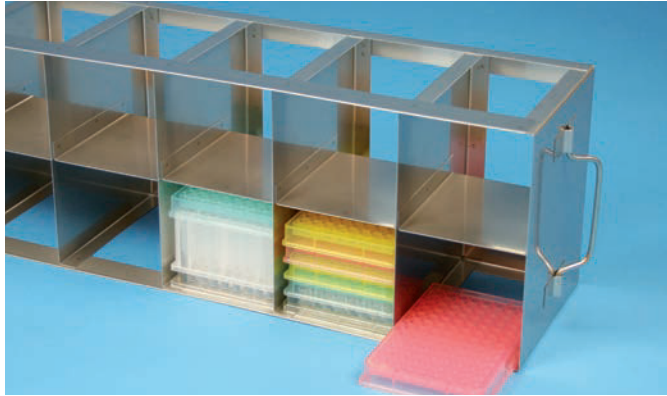

Microtiter Horizontal Racks with one intermediate shelf

For MT-Plates/DeepWells of different heights or large stacks of plates.

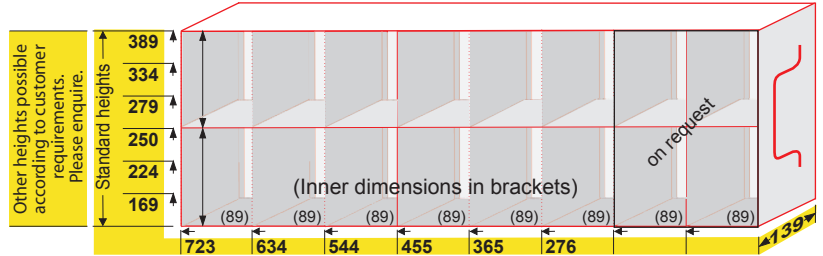

Standard Heights

Cat. No.	Bays	Inner Height	Dimensions
SMX169-3-02AN	3x2	82	276x169
SMX169-4-02AN	4x2	82	365x169
SMX169-5-02AN	5x2	82	455x169
SMX169-6-02AN	6x2	82	544x169
SMX169-7-02AN	7x2	82	634x169
SMX169-8-02AN	8x2	82	723x169
SMX224-3-02AN	3x2	109	276x224
SMX224-4-02AN	4x2	109	365x224
SMX224-5-02AN	5x2	109	455x224
SMX224-6-02AN	6x2	109	544x224
SMX224-7-02AN	7x2	109	634x224
SMX224-8-02AN	8x2	109	723x224

Standard Heights

Cat. No.	Bays	Inner Height	Dimensions
SMX250-3-02AN	3x2	122	276x250
SMX250-4-02AN	4x2	122	365x250
SMX250-5-02AN	5x2	122	455x250
SMX250-6-02AN	6x2	122	544x250
SMX250-7-02AN	7x2	122	634x250
SMX250-8-02AN	8x2	122	723x250
SMX279-3-02AN	3x2	137	276x279
SMX279-4-02AN	4x2	137	365x279
SMX279-5-02AN	5x2	137	455x279
SMX279-6-02AN	6x2	137	544x279
SMX279-7-02AN	7x2	137	634x279
SMX279-8-02AN	8x2	137	723x279

Standard Heights

Cat. No.	Bays	Inner Height	Dimensions
SMX334-3-02AN	3x2	164	276x334
SMX334-4-02AN	4x2	164	365x334
SMX334-5-02AN	5x2	164	455x334
SMX334-6-02AN	6x2	164	544x334
SMX334-7-02AN	7x2	164	634x334
SMX334-8-02AN	8x2	164	723x334
SMX389-3-02AN	3x2	192	276x389
SMX389-4-02AN	4x2	192	365x389
SMX389-5-02AN	5x2	192	455x389
SMX389-6-02AN	6x2	192	544x389
SMX389-7-02AN	7x2	192	634x389
SMX389-8-02AN	8x2	192	723x389



Folding handle positioned vertically as standard.

Alternatives:

Folding handle positioned horizontally or hand grip.

Please enquire if needed.



Microtiter Horizontal Racks with two intermediate shelves

For MT-Plates/DeepWells of different heights or large stacks of plates.

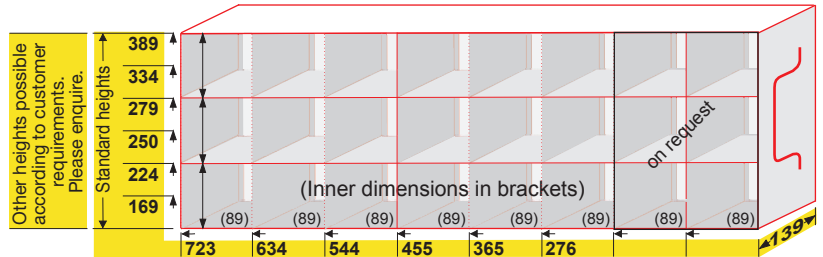

Standard Heights

Cat. No.	Bays	Inner Height	Dimensions
SMX169-3-03AN	3x3	54	276x169
SMX169-4-03AN	4x3	54	365x169
SMX169-5-03AN	5x3	54	455x169
SMX169-6-03AN	6x3	54	544x169
SMX169-7-03AN	7x3	54	634x169
SMX169-8-03AN	8x3	54	723x169
SMX224-3-03AN	3x3	73	276x224
SMX224-4-03AN	4x3	73	365x224
SMX224-5-03AN	5x3	73	455x224
SMX224-6-03AN	6x3	73	544x224
SMX224-7-03AN	7x3	73	634x224
SMX224-8-03AN	8x3	73	723x224

Standard Heights

Cat. No.	Bays	Inner Height	Dimensions
SMX250-3-03AN	3x3	81	276x250
SMX250-4-03AN	4x3	81	365x250
SMX250-5-03AN	5x3	81	455x250
SMX250-6-03AN	6x3	81	544x250
SMX250-7-03AN	7x3	81	634x250
SMX250-8-03AN	8x3	81	723x250
SMX279-3-03AN	3x3	91	276x279
SMX279-4-03AN	4x3	91	365x279
SMX279-5-03AN	5x3	91	455x279
SMX279-6-03AN	6x3	91	544x279
SMX279-7-03AN	7x3	91	634x279
SMX279-8-03AN	8x3	91	723x279

Standard Heights

Cat. No.	Bays	Inner Height	Dimensions
SMX334-3-03AN	3x3	109	276x334
SMX334-4-03AN	4x3	109	365x334
SMX334-5-03AN	5x3	109	455x334
SMX334-6-03AN	6x3	109	544x334
SMX334-7-03AN	7x3	109	634x334
SMX334-8-03AN	8x3	109	723x334
SMX389-3-03AN	3x3	128	276x389
SMX389-4-03AN	4x3	128	365x389
SMX389-5-03AN	5x3	128	455x389
SMX389-6-03AN	6x3	128	544x389
SMX389-7-03AN	7x3	128	634x389
SMX389-8-03AN	8x3	128	723x389



All horizontal racks can be supplied with safety rods if required.

Add 3 mm to height.

Please enquire if needed.

Special designs on request.

For Microtiter Plates or DeepWells of all familiar brands.
Base of drawers closed. Draw front closed to maximum.



Up to 18 mm plate height • with grip rail

Open Design

Cat. No.	SM18	-	x	PC	V	Stop					
						Without O	With M				
16			3x16	4x16	5x16	6x16	7x16	8x16	362	418	
15			3x15	4x15	5x15	6x15	7x15	8x15	339	392	
14			3x14	4x14	5x14	6x14	7x14	8x14	317	366	
13			3x13	4x13	5x13	6x13	7x13	8x13	294	340	
12		on request	3x12	4x12	5x12	6x12	7x12	8x12	272	314	
11			3x11	4x11	5x11	6x11	7x11	8x11	249	288	
10			3x10	4x10	5x10	6x10	7x10	8x10	227	262	
09			3x09	4x09	5x09	6x09	7x09	8x09	204	236	
08			3x08	4x08	5x08	6x08	7x08	8x08	182	210	
07			3x07	4x07	5x07	6x07	7x07	8x07	159	184	
						O = Without Stop	M = With				
						274	360	446	532	618	704
						294	380	466	552	638	724

Example: Cat. No. SM18 - 5 x 13 PCOV

MT drawer rack for 65 microtiter plates **without** safety stop.
Dimensions: WxDxH = 137x446x294 mm

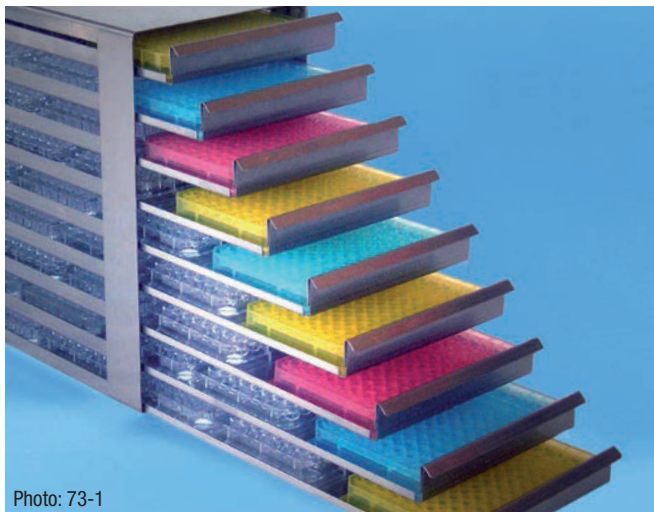

Photo: 73-1



Foto: 73-2

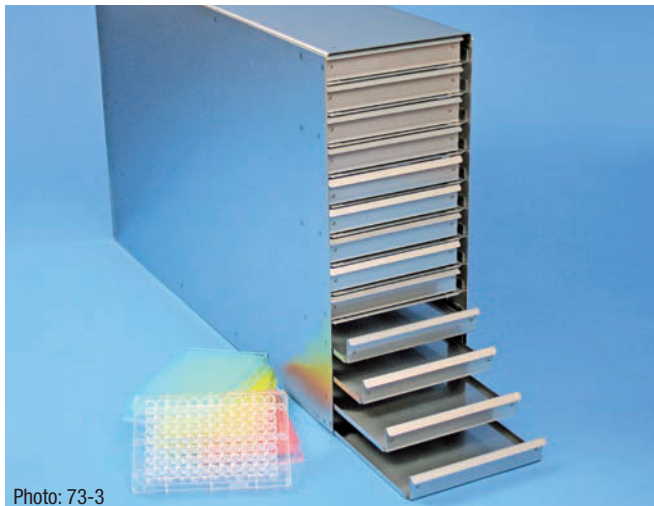

Photo: 73-3



Photo: 73-4

Microtiter Drawer Racks

For MT-Plates 86 x 128 mm (WxD) • Stainless steel

For Microtiter Plates or DeepWells of all familiar brands.
Base of drawers closed. Draw front closed to maximum.



Up to 26 mm plate height • with grip rail

Open Design

Cat. No. SM26 -	x	PC	V	Stop				
				Without O	With M			
13	3x13	4x13	5x13	6x13	7x13	8x13	398	444
12	3x12	4x12	5x12	6x12	7x12	8x12	368	410
11	3x11	4x11	5x11	6x11	7x11	8x11	337	376
10	3x10	4x10	5x10	6x10	7x10	8x10	307	342
09	3x09	4x09	5x09	6x09	7x09	8x09	276	308
08	3x08	4x08	5x08	6x08	7x08	8x08	246	274
07	3x07	4x07	5x07	6x07	7x07	8x07	215	240
06	3x06	4x06	5x06	6x06	7x06	8x06	185	206
O = Without Stop		274	360	446	532	618	704	
M = With		294	380	466	552	638	724	

Example: Cat. No. SM26 - 5 x 13 PCOV

MT drawer rack for 65 microtiter plates **without** safety stop.
Dimensions: WxDxH = 137x446x398 mm



Up to 33 mm plate height • with hand grip

Open Design

Cat. No. SM33 -	x	PB	V	Stop				
				Without O	With M			
10	3x10	4x10	5x10	6x10	7x10	8x10	377	412
09	3x09	4x09	5x09	6x09	7x09	8x09	339	371
08	3x08	4x08	5x08	6x08	7x08	8x08	302	330
07	3x07	4x07	5x07	6x07	7x07	8x07	264	289
06	3x06	4x06	5x06	6x06	7x06	8x06	227	248
05	3x05	4x05	5x05	6x05	7x05	8x05	189	207
04	3x04	4x04	5x04	6x04	7x04	8x04	152	166
O = Without Stop		294	380	466	552	638	724	
M = With		294	380	466	552	638	724	



Up to 39 mm plate height • with hand grip

Open Design

Cat. No. SM39 -	x	PB	V	Stop				
				Without O	With M			
09	3x09	4x09	5x09	6x09	7x09	8x09	393	425
08	3x08	4x08	5x08	6x08	7x08	8x08	350	378
07	3x07	4x07	5x07	6x07	7x07	8x07	306	331
06	3x06	4x06	5x06	6x06	7x06	8x06	263	284
05	3x05	4x05	5x05	6x05	7x05	8x05	219	237
04	3x04	4x04	5x04	6x04	7x04	8x04	176	190
O = Without Stop		294	380	466	552	638	724	
M = With		294	380	466	552	638	724	

For Microtiter Plates or DeepWells of all familiar brands.
Base of drawers closed. Draw front closed to maximum.

Up to 45 mm plate height • with hand grip

Open Design

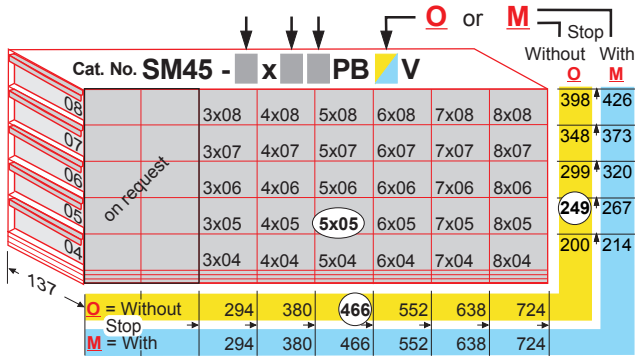

Closed Design

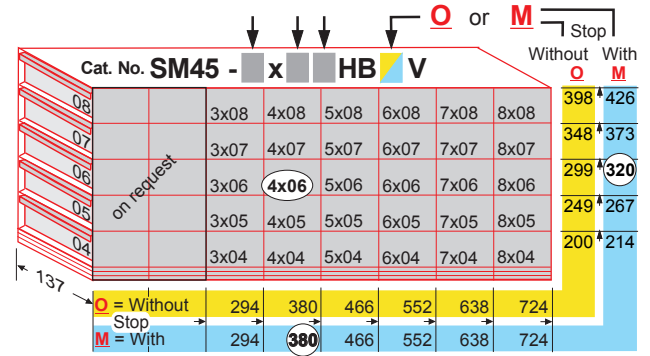

Example: Cat. No. **SM45 - 5 x 0 5 PCOV**

MT drawer rack for 25 microtiter plates **without** safety stop.
Dimensions: WxDxH = 137x466x249 mm

Example: Cat. No. **SM45 - 4 x 0 6 HCMV**

MT drawer rack for 24 microtiter plates **with** safety stop.
Dimensions: WxDxH = 137x380x320 mm

Up to 53 mm plate height • with hand grip

Open Design

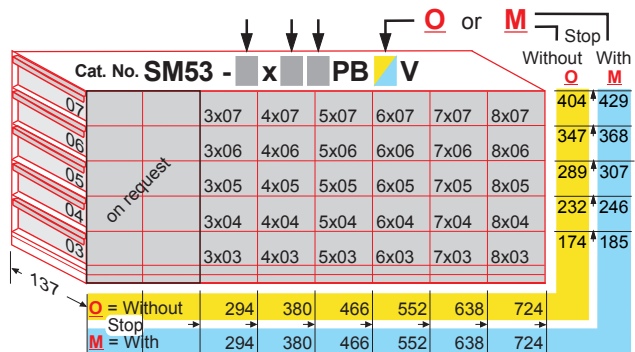

Closed Design

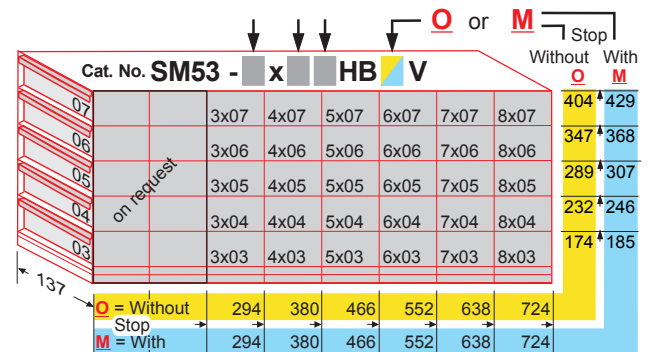

Up to 58 mm plate height • with hand grip

Open Design

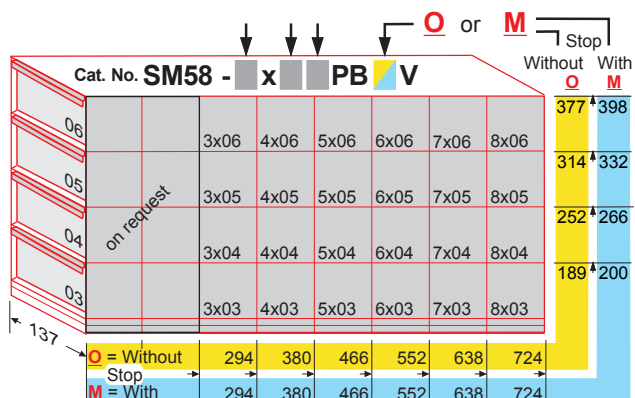

Closed Design

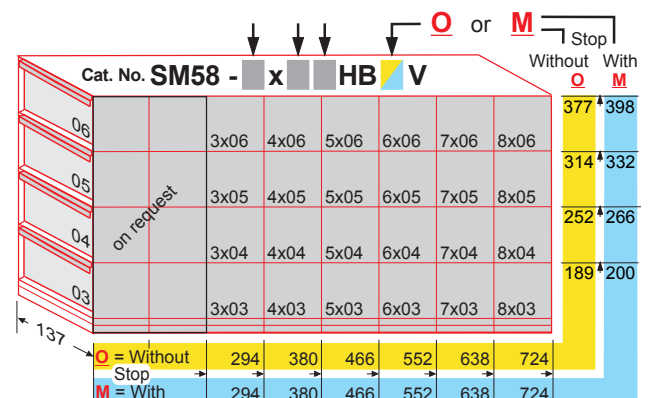



Obi Box 25 Slide Box for 25 Slides

With index card and numbering in lower section.
For slides 76x26 mm. Made of polystyrene.

96x122x35 mm (WxDxH).

Cat. No.	Colour
KOS35-25BU	blue
KOS35-25GR	green
KOS35-25RE	red
KOS35-25WH	white
KOS35-25YE	yellow

Matching Racks

Vertical Racks
Please request!

Horizontal Racks
Please request!

Drawer Racks
Please request!

Upright Bins
page 47 + 53



Obi Box 50 Slide Box for 50 Slides

With index card and numbering in lower section.
For slides 76x26 mm. Made of polystyrene.

100x230x35 mm (WxDxH).

Cat. No.	Colour
KOS35-50BU	blue
KOS35-50GR	green
KOS35-50RE	red
KOS35-50WH	white
KOS35-50YE	yellow

Matching Racks

Vertical Racks
Please request!

Horizontal Racks
Please request!

Drawer Racks
Please request!

Upright Bins
page 47 + 53

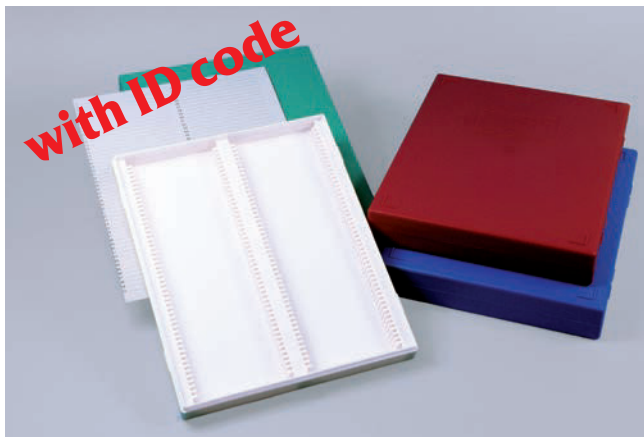

Obi Box 100 Slide Box for 100 Slides

With index card and numbering in lower section.
For slides 76x26 mm. Made of polystyrene.

185x230x35 mm (WxDxH).

Cat. No.	Colour
KOS35-100BU	blue
KOS35-100GR	green
KOS35-100RE	red
KOS35-100WH	white
KOS35-100YE	yellow

Matching Racks

Vertical Racks
Please request!

Horizontal Racks
Please request!

Drawer Racks
Please request!

Upright Bins
page 47 + 53





VICTOR Box 57 / 10x10 • height 57 mm fix

Inner height 50 mm. With hinged lid. 10x10 divider holds 100 tubes up to 12.5 mm Ø. With alphanumeric ID code on the lid. Dimensions WxDxH = 141x151x57 mm

Cat. No.	Colour
KVH57-S100NA	natural
KVH57-S100NY	neon-yellow
KVH57-S100NB	neon-blue
KVH57-S100NG	neon-green
KVH57-S100NV	neon-violet
KVH57-S100NP	neon-red/pink
KVH57-S100BB	black/black*

*black/black: Lower half and lid black for light-sensitive samples

Matching Racks

Vertical Racks
Please request!

Horizontal Racks
Please request!

Drawer Racks
Please request!

Upright Bins
page 47 + 53



VICTOR Box 59 / 5x10 • height 59 mm fix

Inner height 50 mm. With hinged lid. 5x10 divider holds 50 tubes up to 12.0 mm Ø. With alphanumeric ID code on 2 sides. Dimensions WxDxH = 141x85x59 mm

Cat. No.	Colour
KVA59-S50NA	natural
KVA59-S50NY	neon-yellow
KVA59-S50NB	neon-blue
KVA59-S50NG	neon-green
KVA59-S50NV	neon-violet
KVA59-S50NO	neon-orange
KVA59-S50BB	black/black*

*black/black: Lower half and lid black for light-sensitive samples

Matching Racks

Vertical Racks
Please request!

Horizontal Racks
Please request!

Drawer Racks
Please request!

Upright Bins
page 47 + 53

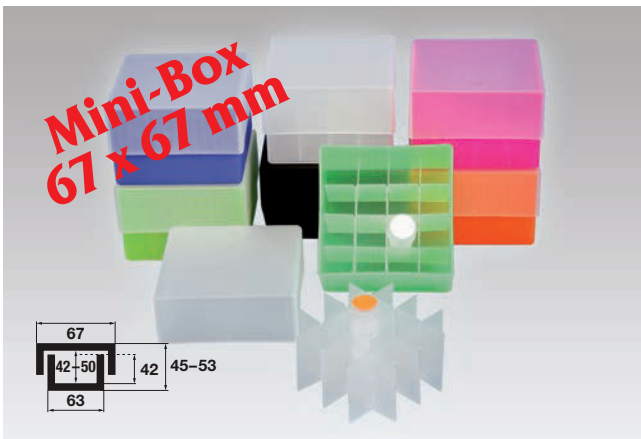

EPPi® 45 Junior • height 45–60 mm variable

Mini-Box with 67x67 mm outside dimensions incl. lid. Please select with or without grid divider. Other colours and grid dividers on request.

Cat. No.	Colour	Cat. No.	Colour
KEA45-VJxxNA	natural	KEA45-VJxxNP	neon-red/pink
KEA45-VJxxNY	neon-yellow	KEA45-VJxxNO	neon-orange
KEA45-VJxxNB	neon-blue	KEA45-VJxxBB	black/black*
KEA45-VJxxNG	neon-green		

↑ xx Please complete item number.

- xx = 16 (4 x 4 compartments for tubes up to 14 mm Ø)
- xx = 9 (3 x 3 compartments for tubes up to 20 mm Ø)
- xx = 1 (Empty box without grid divider)

Additional grid dividers on request.

*black/black: Lower half and lid black for light-sensitive samples

Matching Racks

Vertical Racks
Please request!

Horizontal Racks
Please request!

Drawer Racks
Please request!

Upright Bins
page 47



FoxBox 136x136 mm • 10x10 Grid Divider

Plastic-coated fiberboard box, waterproof. With alphanumeric ID code on the side as well as numeric ID code 1-100 on the lid. Inserted grid divider 10x10 for 100 tubes up to approx. 12.5 mm Ø. Height of grid divider 30 mm. Other colours and dimensions can be produced on request.

Cat. No.	Ext. Height	Grid Divider	Colour	Inner Height
6508	52 mm	10x10	white	48 mm
6509	75 mm	10x10	white	71 mm
6510	95 mm	10x10	white	91 mm

Matching Racks

Vertical Racks
page 50

Horizontal Racks
page 51 – 52

Drawer Racks
page 54 – 57

Upright Bins
page 53

Isotherm Quick Freeze + Isotherm Mini Cooler



Isotherm Quick Freeze -70°C

For 12 tubes from 0.5 to 2.0 ml. With alphanumeric ID code on the transparent lid and the lower section.

For rapid and repeated refrigeration in the molecular biology laboratory. Can be used repeatedly for up to 45 minutes. Made of resistant polycarbonate filled with non-toxic insulating fluid. No direct contact between the tube and the insulating fluid. With non-slip feet.

Volume	Time taken to attain	
	-20°C (isopropanol)	0°C (water)
1.5 ml*	with isopropanol 2.0 min.	with water 3.2 min.
0.5 ml*	with isopropanol/adaptor 2.8 min.	with water 4.0 min.

* Time taken with micro centrifuge tubes (approx.)

Cat. No.	Colour	Cells	Tubes (ml)	WxDxH (mm)
LCCQ51140012	white	4x3	0.5 up to 2.0	151x108x125



Isotherm Mini Cooler 0.5 ml / 2.0 ml

For tubes from 0.5 to 2.0 ml. With alphanumeric ID code on the lid and the lower section.

Temperature-conditioning of reagents (enzymes, DNA, RNA, cell suspensions, etc.) on the laboratory bench. Made of resistant polycarbonate filled with non-toxic insulating fluid. No direct contact between the tube and the insulating fluid. With non-slip feet.

Cat. No.	Temp.	Colour	Cells	Lid	Storage time	WxDxH (mm)
LCCM51160012	0°C	red	4x3	without gel	<1°C/3.5 hrs.	151x108x125
LCCM51150012	-20°C	yellow	4x3	without gel	<-15°C/1 hrs.	151x108x125
LCCM51160032	0°C	red	8x4	with gel	<1°C/5 hrs.	243x157x100**
LCCM51160032C	0°C	red	8x4	without gel	<1°C/3.5 hrs.	243x157x100**
LCCM51150020	-20°C	yellow	5x4	without gel	<-15°C/1 hrs.	220x163x113**
LCCM51150032	-20°C	yellow	8x4	with gel	<-15°C/2 hrs.	243x157x100**
LCCM51150032C	-20°C	yellow	8x4	without gel	<-15°C/1 hrs.	243x157x100**

** Height without fastening clip. With fastening clip in place, the height increases by approx. 50 mm.

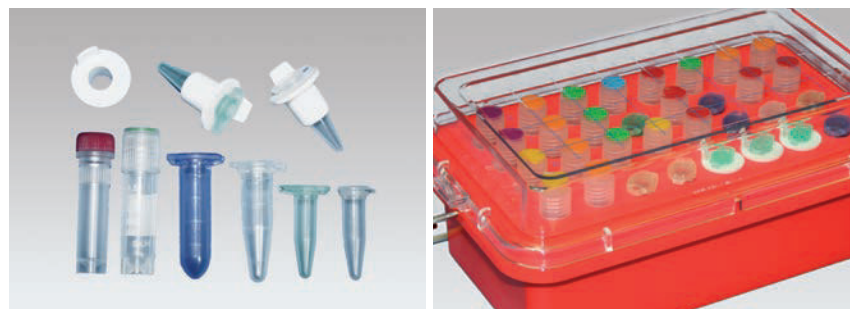

Isotherm Mini Cooler 15 ml + Vacutainer¹⁾

For 12 centrifuge tubes 5 ml and 15 ml respectively Vacutainer¹⁾. With alphanumeric ID code on the transparent lid and the lower section.

Made of resistant polycarbonate filled with non-toxic insulating fluid. No direct contact between the tube and the insulating fluid. With non-slip feet.

Cat. No.	Temp.	Colour	Cells	Lid	Storage time	WxDxH (mm)
LCCM51161600	0°C	red	4x3	without gel	<1°C/5 hrs.	197x140x190 for tubes Ø16–17 mm (e.g. 15 ml centrifuge tubes)
LCCM51161300	0°C	red	4x3	without gel	<1°C/5 hrs.	197x140x190 for tubes Ø12–13 mm (e.g. Vacutainer ¹⁾)

¹⁾ Vacutainer is a registered trademark of Becton Dickinson.



Isotherm Mini Cooler + Cryo Freezer



Isotherm Mini Cooler -20°C PCR

Specially developed to protect enzymes and other biological specimens while working at the laboratory bench. Removable aluminium block with 96 holes in universal 96-well standard format. Mini Cooler made of resistant polycarbonate filled with non-toxic insulating fluid. With non-slip feet.

With alphanumeric ID code on the aluminium block.

0.2 ml PCR tubes individually or in strips as well as 96-well plates are maintained at between -15°C and -20°C for up to 2 hours.

Cat. No.	Temp.	Cells	Lid	Storage time	WxDxH (mm)
LCCM96PCR	-20°C	12x8	without gel	<-20°C/2 hrs.	220x163x150**

** Height without fastening clip. With fastening clip in place, the height increases by approx. 50 mm.



Cryo Freezer 1°C

Made of transparent polycarbonate. Lid and tube holders made of HDPE, with foam liner.

Enables critical, repeatable cooling rate of approx. 1°C/minute for successful cryopreservation and optimum cell yield.

Easy to use with 100 % isopropanol and a freezing device.

For up to 18 cryo tubes from 1.0 to 2.0 ml. No direct contact between the tubes and the alcohol. Instructions for use printed on device. Stackable.

Cat. No.	Tubes	Dimensions (mm)
LCC5100	18	H x Ø = 86 x 117, Lid-Ø 120

Straight-Side Wide-Mouth Jars for specimen storage



Straight-Side Wide-Mouth Jars

Large wide-necked opening for easy filling. Made of transparent polycarbonate with white or blue PP closure. Window-clear. High impact resistance. Non-toxic. Stackable. Popular screw-top jar also for freezing down to -90°C. Fully unscrew the lid prior to autoclaving.

Cat. No.	Content		Ø Lid	Height
LPB211601251	125 ml	1 pcs.	70 mm	74 mm
LPB211602501	250 ml	1 pcs.	70 mm	119 mm
LPB211605001	500 ml	1 pcs.	120 mm	86 mm
LPB211610001	1,000 ml	1 pcs.	120 mm	142 mm

Thorbi® Insulated Container + Upright Bins made of Plastic



Thorbi® Insulated Container without lid

Useful for ice, dry ice and liquid nitrogen. One-piece foamed PVC, thick-walled with very good insulating properties. Unbreakable during normal use. Chemically resistant to acids, alkalis, salts, alcohol, acetone, etc. Temperature-resistant from -196 °C up to +93 °C.

Content: 1 litre

WxDxH: 215x188x118 mm

Content: 4 litre

WxDxH: 355x225x125 mm

Content: 9 litre

WxDxH: 503x356x155 mm

Cat. No.	Colour	Cat. No.	Colour	Cat. No.	Colour
LCB110BU	blue	LCB140BU	blue	LCB190BU	blue
LCB110GR	green	LCB140GR	green	LCB190GR	green
LCB110RE	red	LCB140RE	red	LCB190RE	red
LCB110BL	black	LCB140BL	black	LCB190BL	black



Thorbi® Insulated Container with lid

Suitable for ice, dry ice and liquid nitrogen. One-piece foamed PVC, thick-walled with very good insulating properties. Unbreakable during normal use. Chemically resistant to acids, alkalis, salts, alcohol, acetone, etc. Temperature-resistant from -196 °C up to +93 °C.

Content: 2.5 litre

WxDxH: 338x285x120 mm

Content: 4.5 litre

WxDxH: 343x285x187 mm

Cat. No.	Colour	Cat. No.	Colour
LCB225BU	blue	LCB245BU	blue
LCB225GR	green	LCB245GR	green
LCB225RE	red	LCB245RE	red
LCB225BL	black	LCB245BL	black



Thorbi® Upright Bins made of Plastic

Thorbi® Upright Bins made of tough 3-mm acrylic glass, transparent. Die-cut handles at both ends. With 2 movable partitions in the standard unit. Labelling tabs and cards optional. Card size WxH = 25x50 mm. Modified designs possible.

Cat. No.	Inside WxDxH (mm)	Outside WxDxH (mm)
LPB900-450104	130x444x100 ¹⁾	140x450x104 ¹⁾
LPB900-500104	130x494x100 ¹⁾	140x500x104 ¹⁾
LPB900-550104	130x544x100 ¹⁾	140x550x104 ¹⁾
LPB900-600104	130x594x100 ¹⁾	140x600x104 ¹⁾
LPB900-650104	130x644x100 ¹⁾	140x650x104 ¹⁾

¹⁾ Different dimensions possible.



Cat. No.	Accessories
LPH800-100130G	Partition height = 70, width = 130
LPH901	Clip-on labelling tab
LPH910PW	Labelling cards, plastic, white, 50 pcs.
LPH910PY	Labelling cards, plastic, yellow, 50 pcs.
LPH910KW	Labelling cards, cardboard, white, 50 sheets à 35 pcs.



Thorbi® Tube Rack, Boxes made of stainless steel, Safety clamping springs

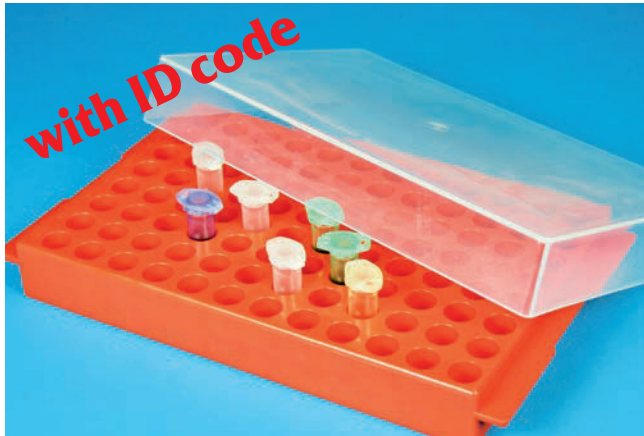

with ID code

Thorbi® Tube Rack with natural lid

Reversible. For 96 reaction vessels 1.5/2.0 ml on one side or 96 reaction vessels 0.5 ml on the other side. With alphanumeric ID code on the rack. Made of PP. Temperature-resistant from -130 °C up to +121 °C. Autoclavable.

Cat. No.	Colour	Cells 1.5 / 2.0 ml	Cells 0.5 ml	External Dimensions WxDxH (mm)
LCRKR96NA	natural	8x12 (96)	8x12 (96)	220x130x47
LCRKR96BU	blue	8x12 (96)	8x12 (96)	220x130x47
LCRKR96YE	yellow	8x12 (96)	8x12 (96)	220x130x47
LCRKR96GR	green	8x12 (96)	8x12 (96)	220x130x47
LCRKR96OR	orange	8x12 (96)	8x12 (96)	220x130x47
LCRKR96PI	pink	8x12 (96)	8x12 (96)	220x130x47
LCRKR96RE	red	8x12 (96)	8x12 (96)	220x130x47



with ID code

Thorbi® Kryo tube rack without lid

Reversible. For 80 reaction vessels 1.5/2.0 ml on one side or 60 reaction vessels 0.5 ml on the other side. With alphanumeric ID code on the rack. Made of PP. Temperature-resistant from -130 °C up to +121 °C. Autoclavable.

Cat. No.	Colour	Cells 1.5 / 2.0 ml	Cells 0.5 ml	External Dimensions WxDxH (mm)
LCRKR80NA	natural	5x16 (80)	4x15 (60)	230x67x27
LCRKR80BU	blue	5x16 (80)	4x15 (60)	230x67x27
LCRKR80YE	yellow	5x16 (80)	4x15 (60)	230x67x27
LCRKR80GR	green	5x16 (80)	4x15 (60)	230x67x27
LCRKR80OR	orange	5x16 (80)	4x15 (60)	230x67x27
LCRKR80PI	pink	5x16 (80)	4x15 (60)	230x67x27
LCRKR80RE	red	5x16 (80)	4x15 (60)	230x67x27



with and without grid divider

CNS Box • Stainless steel

Without grid divider. The corners of the boxes are not welded.

Cat. No.	Inside WxDxH (mm)	Outside WxDxH (mm)
KA1050E05	129x129x50	133x133x52
KA1075E05	129x129x75	133x133x77
KA1100E05	129x129x100	133x133x102

Other dimensions also available for grid dividers and hole inserts on request.

Grid dividers made of stainless steel • height 30 mm

Cat. No.	Cells	Tubes Ø
RA10301010E05	10x10	up to approx. 12.5 mm
RA10300909E05	9x9	up to approx. 13.9 mm
RA10300808E05	8x8	up to approx. 15.7 mm
RA10300707E05	7x7	up to approx. 17.9 mm

Matching Racks

Vertical Racks
page 39

Horizontal Racks
page 40–41

Drawer Racks
page 42–43

Upright Bins
page 47



Safety clamping springs

The safety clamping springs ensure that the cryoboxes are firmly secured in vertical and horizontal racks. They are simply placed on the lid of the cryobox and pushed into the slot together with the cryobox. This prevents the cryoboxes from slipping out if the rack is tilted. There is no further need to worry about the risk of samples sliding out when work is being carried out on upright freezers and chest freezers or during transport. When the cryobox is withdrawn, the safety clamping spring is removed together with the cryobox. The safety clamping springs are suitable for all racks and boxes if the gap between the cryobox and the base above it is between 1 and 6 mm. Suitable for all makes.

Cat. No.	Packing Unit (pcs.)
LA4924	10



Thorbi® Cryo tubes • external thread • sterile

- gamma sterilized
- in resealable bags
- RNase-/DNase-/DNA- and pyrogen free
- not cytotoxic, cadmium free
- USP Class VI, SAL 10⁻⁶
- Made of PP. Autoclavable.
- Colour-coded due cap inserts (please order separately).
- temperature-resistant from -196 °C up to +121 °C
- for storage in the vapour phase of liquid nitrogen
- graduated, with writing area
- fast unscrewing and tightening
- star-base foot, free-standing
- single-handed operation with EPPi® Cryo tube rack possible (see below)

Cat. No.	Content	Ø x Height (mm)	Packing Unit
LCR1ANSMYX	1.2 ml	12.5 x 35	1,000 (40x25) pcs./pack
LCR2ANSMYX	2.0 ml	12.5 x 47	1,000 (40x25) pcs./pack
LCR5ANSMYD	5.0 ml	12.5 x 90	500 (20x25) pcs./pack



Thorbi® Cryo tubes • internal thread • sterile

- gamma sterilized
- in resealable bags
- RNase-/DNase-/DNA- and pyrogen free
- not cytotoxic, cadmium free
- USP Class VI, SAL 10⁻⁶
- Made of PP. Silicone seal. Autoclavable.
- Colour-coded due cap inserts (please order separately).
- temperature-resistant from -196 °C up to +121 °C
- for storage in the vapour phase of liquid nitrogen
- graduated, with writing area
- fast unscrewing and tightening
- star-base foot, free-standing
- single-handed operation with EPPi® Cryo tube rack possible (see below)

Cat. No.	Content	Ø x Height (mm)	Packing Unit
LCR1BYSMYX	1.2 ml	12.5 x 42	1,000 (40x25) pcs./pack
LCR2BYSMYX	2.0 ml	12.5 x 49	1,000 (40x25) pcs./pack
LCR5BYSMYD	5.0 ml	12.5 x 91	500 (20x25) pcs./pack



Thorbi® colour inserts for cryo tubes

Suitable for all Thorbi® Cryo tubes. The coloured cap inserts (PP) make it easier to find and retrieve samples. 6 different colours available. Can be easily pressed into the top of the cap. Very easy to change. Suitable for writing on. In resealable bags.

Cat. No.	Colour	Packing Unit
LCRCCBU	blue	500 (5x100) pcs./pack
LCRCCYE	yellow	500 (5x100) pcs./pack
LCRCCGR	green	500 (5x100) pcs./pack
LCRCCRE	red	500 (5x100) pcs./pack
LCRCCWH	white	500 (5x100) pcs./pack
LCRCCMX	mix (6 colours assorted)	600 (6x100) pcs./pack



Thorbi® Cryo tube rack 5 x 10

Non-slip Cryo tube rack with locking system for the star-base foot prevents the tubes from rotating when tightening and unscrewing the caps. Single-handed operation to make work fast and comfortable. For 5 x 10 cryo tubes (0.5 ml up to 5.0 ml). Alphanumeric coding. Made of Polycarbonate (PC). Temperature-resistant from -196 °C up to +121 °C. Autoclavable.

Cat. No.	Colour	Dimensions WxDxH (mm)	Packing Unit
LCRWS50BU	blue	195x100x25	1
LCRWS50GR	green	195x100x25	1
LCRWS50RE	red	195x100x25	1
LCRWS50WH	white	195x100x25	1
LCRWS50YE	yellow	195x100x25	1

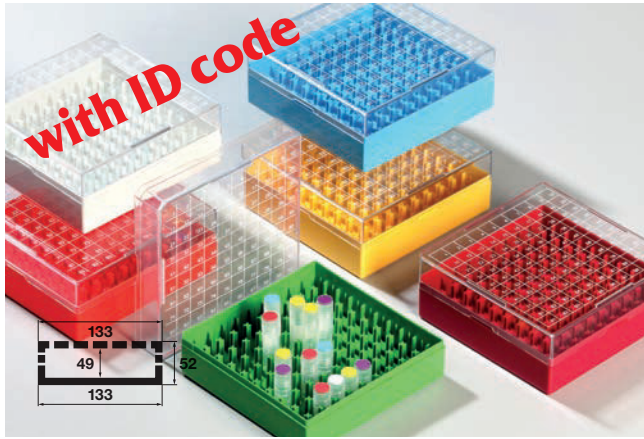

Thorbi® Cryobox 100 / 10x10 • height 52 mm fix

Thorbi® Cryobox 100-place made of extra strong polycarbonate. For 10x10 EPPi® cryo tubes 0.5 up to 2.0 ml with male thread or ordinary cryo tubes with female thread. Transparent lid with numeric ID code (1-100). 133x133x52 mm (WxDxH).

Cat. No.	Colour	Cells	for Tubes	Height
KPC50-C100WH	white	10x10	0.5 up to 2.0 ml	52 mm
KPC50-C100BU	blue	10x10	0.5 up to 2.0 ml	52 mm
KPC50-C100YE	yellow	10x10	0.5 up to 2.0 ml	52 mm
KPC50-C100GR	green	10x10	0.5 up to 2.0 ml	52 mm
KPC50-C100RE	red	10x10	0.5 up to 2.0 ml	52 mm
KPC50-C100OR	orange	10x10	0.5 up to 2.0 ml	52 mm

Matching Racks

Vertical Racks
page 39

Horizontal Racks
page 40–41

Drawer Racks
page 42–43

Upright Bins
page 47

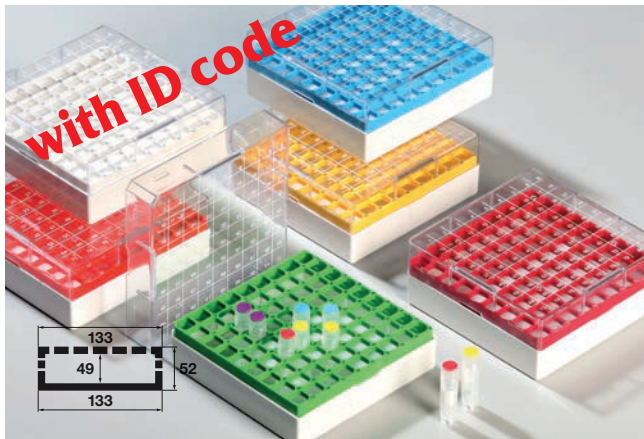

Thorbi® Cryobox 81 / 9x9 • height 52 mm fix

Thorbi® Cryobox 81-place made of extra strong polycarbonate. For 9x9 cryo tubes 2.0 ml. Transparent lid with numeric ID code (1-81). 133x133x52 mm (WxDxH).

Cat. No.	Colour	Cells	for Tubes	Height
KPC50-C81WH	white	9x9	2.0 ml	52 mm
KPC50-C81BU	blue	9x9	2.0 ml	52 mm
KPC50-C81YE	yellow	9x9	2.0 ml	52 mm
KPC50-C81GR	green	9x9	2.0 ml	52 mm
KPC50-C81RE	red	9x9	2.0 ml	52 mm
KPC50-C81OR	orange	9x9	2.0 ml	52 mm

Matching Racks

Vertical Racks
page 39

Horizontal Racks
page 40–41

Drawer Racks
page 42–43

Upright Bins
page 47

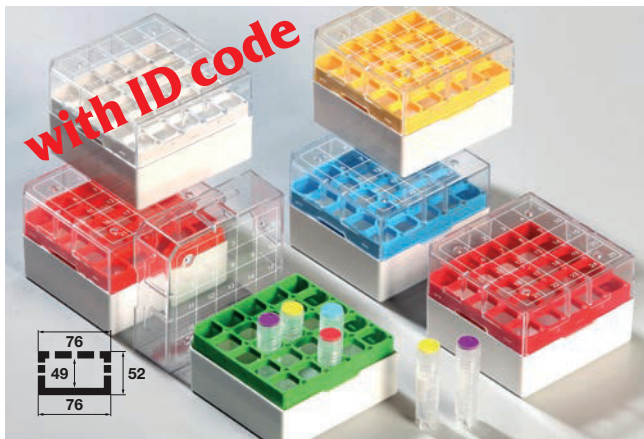

Thorbi® Cryobox 25 / 5x5 • height 52 mm fix

Thorbi® Cryobox 25-place made of extra strong polycarbonate. For 5x5 cryo tubes 2.0 ml. Transparent lid with numeric ID code (1-25). 76x76x52 mm (WxDxH).

Cat. No.	Colour	Cells	for Tubes	Height
KPC50-C25WH	white	5x5	2.0 ml	52 mm
KPC50-C25BU	blue	5x5	2.0 ml	52 mm
KPC50-C25YE	yellow	5x5	2.0 ml	52 mm
KPC50-C25GR	green	5x5	2.0 ml	52 mm
KPC50-C25RE	red	5x5	2.0 ml	52 mm
KPC50-C25OR	orange	5x5	2.0 ml	52 mm

Matching Racks

Vertical Racks
page 69

Horizontal Racks
page 69

Drawer Racks
Please request!

Upright Bins
page 47 + 53

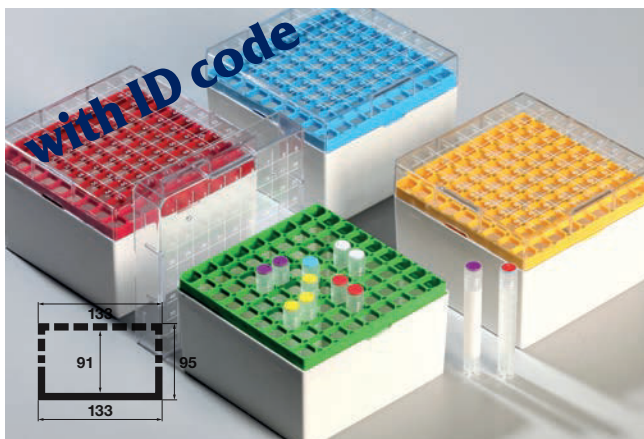

Thorbi® Cryobox 81H / 9x9 • height 95 mm fix

Thorbi® Cryobox 81-place made of extra strong polycarbonate. For 9x9 cryo tubes 5.0 ml. Transparent lid with numeric ID code (1-81). 133x133x95 mm (WxDxH).

Cat. No.	Colour	Cells	for Tubes	Height
KPC95-C81BU	blue	9x9	5.0 ml	95 mm
KPC95-C81YE	yellow	9x9	5.0 ml	95 mm
KPC95-C81GR	green	9x9	5.0 ml	95 mm
KPC95-C81RE	red	9x9	5.0 ml	95 mm

Matching Racks

Vertical Racks
page 39

Horizontal Racks
page 40–41

Drawer Racks
page 45

Upright Bins
page 47

Stainless Steel Organizer Units – on request



Photo: 84-1



Photo: 84-2



Photo: 84-3



Photo: 84-4



Photo: 84-5



Photo: 84-6



Photo: 85-1

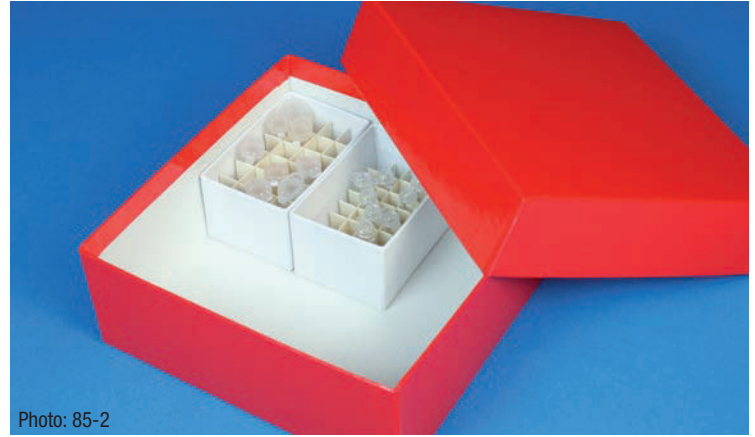

Photo: 85-2

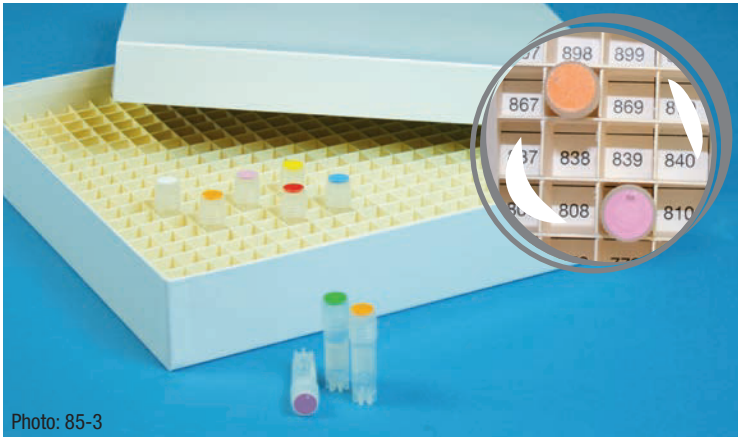

Photo: 85-3

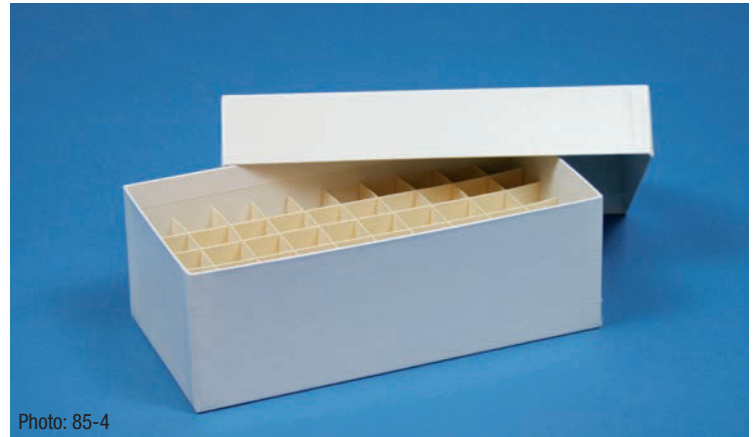

Photo: 85-4

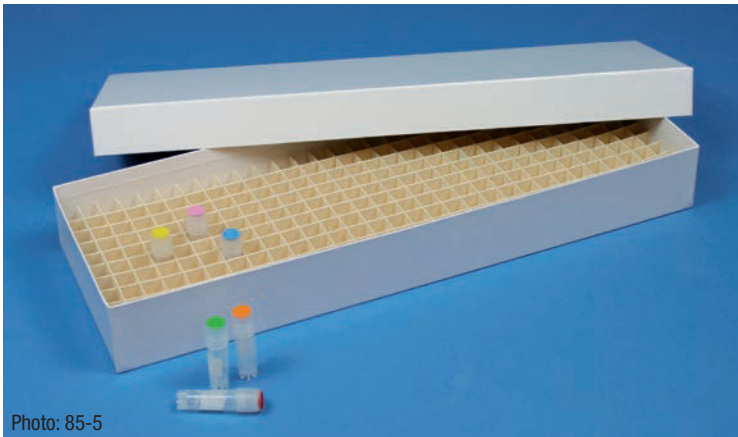

Photo: 85-5

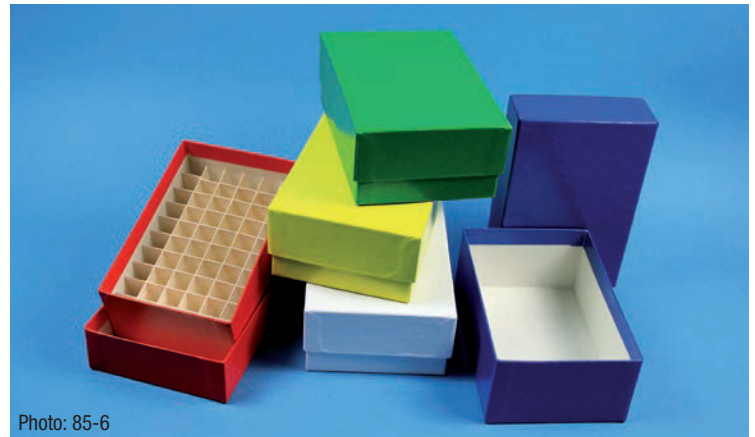

Photo: 85-6



Photo: 85-7

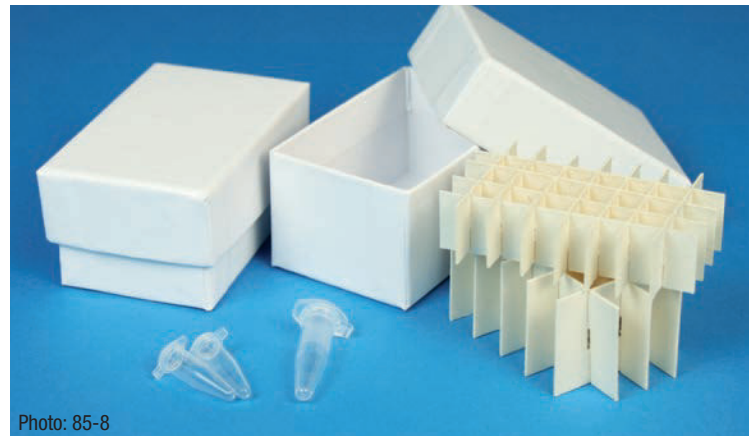

Photo: 85-8

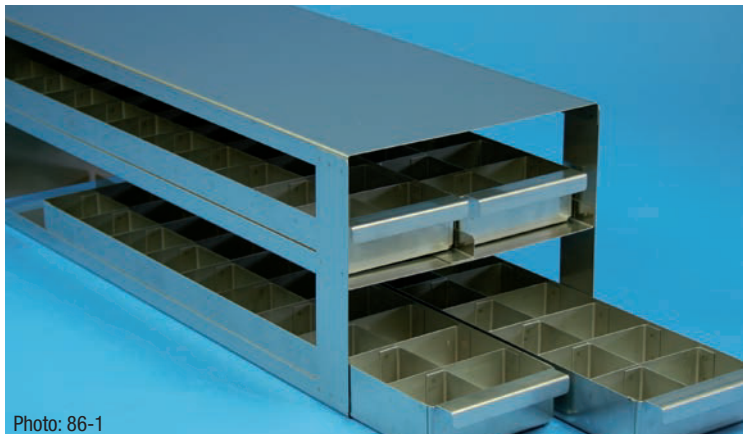

Photo: 86-1

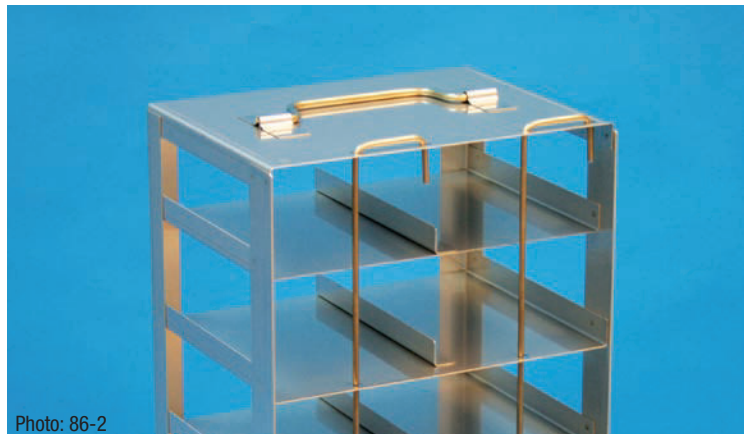

Photo: 86-2



Photo: 86-3

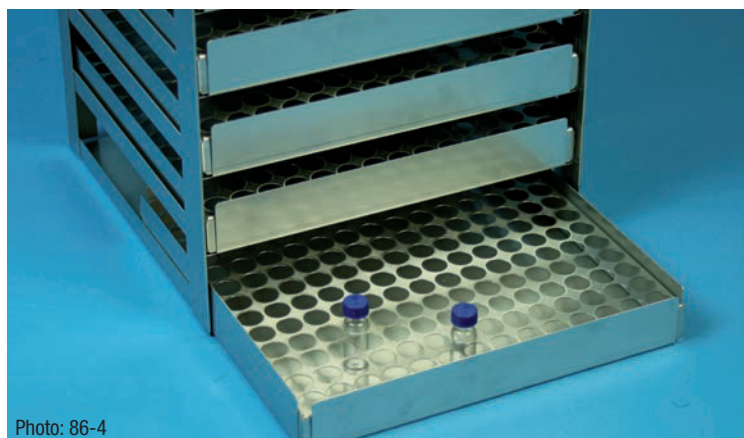

Photo: 86-4



Foto: 86-5



Photo: 86-6



Photo: 86-7



Photo: 86-8

Nothing is impossible!

Well-organized freezers and refrigerators are an essential prerequisite for systematic, efficient and ultimately successful work – not only in scientific laboratories.

We provide the means to fulfil this prerequisite and devote ourselves to the task from a sense of conviction and with passion.

In fact, it is a passion for practical details and our liking for intelligent solutions.

This catalogue contains many suggestions for the interior fittings of all brands of refrigerator and freezer cabinets as well as freezer chests.

If you are looking for a solution to a problem or need assistance in setting up your refrigeration equipment, please contact us.

We will always be able to offer you a solution and will be glad to help you.

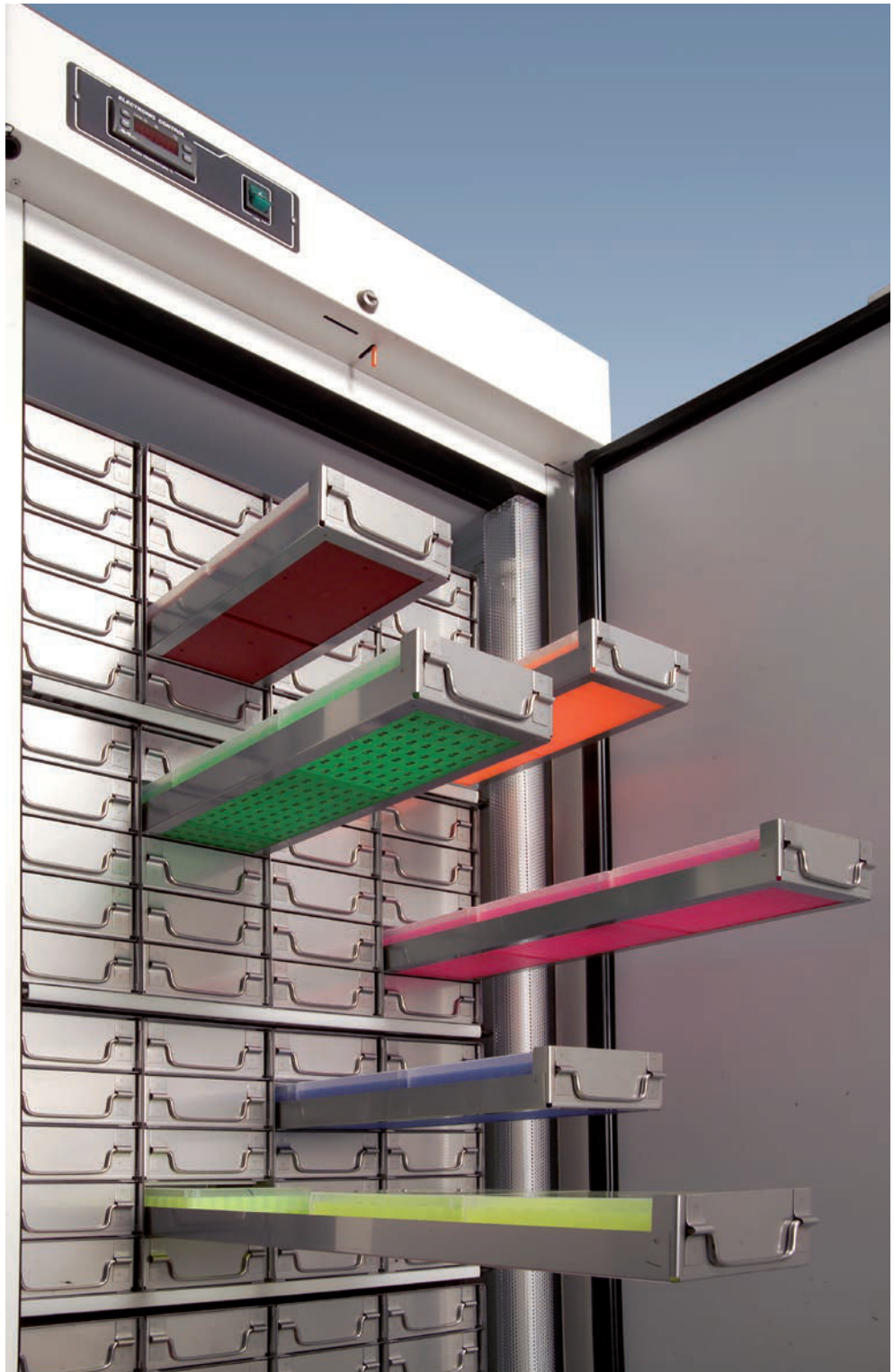

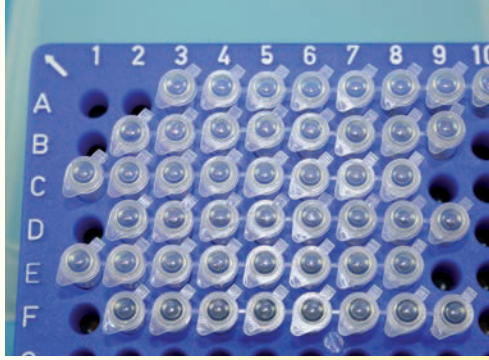

All rights and changes reserved · © 2023 Copyright by National Lab · Reg: ORD-KAT-EN-230627



National Lab GmbH
Refrigeration Technology
Industriestrasse 30
23879 Moelln
Tel: +49 45 42/84 91-70
E-mail: Kryobox@NationalLab.com
www.Kryobox.de • www.EPPibox.com
www.NationalLab.com

